

Installation and Maintenance Manual

Alarm Valve Combo Unit Alert-1 v1.4



Table of Contents

User Responsibility	4
Introduction	5
Features	5
Installation of Valve Boxes	6
Maintenance	7
Description of Modules	8
Common to All Alarms	8
System Power Supply	8
Annunciator Module	8
Alarm Valve Display Module	8
Sensor Module	8
Installation of Alarm	9-10
Local Sensor Only	9
Standing Pressure Test	9
Frame/Module Assembly	9
Sensor	10
Local	10
Remote	10
Wiring	11
System Power Supply	11
Annunciator Module	11
Sensor Module	11
Local	11
Remote	11
Annunciator Module	12
Noise Level Control	12
Control of Remote Alarm Buzzer	12

Table of Contents

The Display Module	13-16
Pressure Only	13
HIGH/LOW Alarm Set Point Adjustments	13
PSI/kPa/BAR selection	14
Vacuum Only	14
LOW Vacuum Alarm Set Point Adjustment	14
InchHg/kPa/BAR selections	15
Common Settings for Pressure and Vacuum	15
Repeat Alarm Enable/Disable	15
Setting Factory Default	15
Setting Gas Identification Switches	16
Chart of Gas Specific Settings of Dip-Switches	16
Troubleshooting Guide	17-19
Table of Error Codes	17-19
Error Code Messages on the Display Module	19
Model Numbers	20-21
Spare Parts Numbers	22-23
Dimensions	24-25
Appendix A - Wiring Diagram - Auto-Switching Power Supply	26
Appendix B - Wiring Diagram - Annunciator	27
Appendix C - Wiring Diagram - Alarm Valve Combo Unit	28
Appendix D - Wiring Diagram - Remote Alarm Valve Combo Unit	29
Appendix E - Wiring Diagram - Alarm Valve Combo Unit to Master Module	30
Appendix F - Technical Specifications	31

User Responsibility

The information contained in this Installation and Operation Maintenance Manual pertains only to the Alarm Valve Combo Unit. This product will perform to conformity as described in this manual when assembled, operated, maintained and serviced in accordance with the installation instructions provided.

The Alarm Valve Combo Unit must be checked periodically. Parts that are broken, missing, worn, distorted or contaminated must be replaced immediately. Should such repair or replacement become necessary, please contact Amico Corporation or their distributors.

All alarms should not be repaired or altered without prior written or verbal approval of Amico Corporation or its distributors. Failure to comply will void all warranty on the alarm.

Statements in this manual preceded by the words **WARNING**, **CAUTION**, **DANGER** and **NOTE** are of special significance. Please read these sections carefully.



WARNING: denotes steps which can prevent injury.



CAUTION: denotes steps which can prevent damage to equipment.



DANGER: denotes steps which can prevent electrical shock to equipment or prevent serious injury and/or death.

Introduction

The Alarm Valve Combo Unit is a 2 in 1 design, which combines the Area Alarm and Zone Valve Box, to compensate for space restrictions.

Amico Shutoff Valves are used to stop the flow of medical gas or vacuum in the medical gas distribution pipeline in cases of emergency or maintenance.

Valve Boxes must be installed to enclose the shutoff valves when the valves are located in areas accessible to unauthorized personnel.

The Amico medical gas Alarm Valve Combo Unit incorporates the latest microprocessor technology for alarm and surveillance systems. The alarm has been designed to provide user flexibility and reliability. This manual will enable the customer to install, use and maintain the alarm properly.

All gases or vacuum are displayed with large red LED's for clear visibility. To facilitate the monitoring function by hospital personnel, a trend bar is provided to show the direction of the gas/vacuum pressure. Under normal operation, the gas trend indicator will be in the GREEN - OK position. If the gas pressure approaches alarm condition, the trend indicator will display a RED - Caution indicator. If an alarm condition occurs, the buzzer will sound.

Features

- Individual microprocessor on each display and sensor module.
- Gas specific sensors can be mounted locally or remotely, up to 2,500 feet (750 m), utilizing 22 gauge shielded twisted pair (2 shielded wires).
- The DISS gas specific sensor is housed in a tamper-proof enclosure. The Sensor Module is housed in an anodized aluminum and nickle-plated brass enclosure to act as an interference barrier.
- The Sensor Module is the smallest, computer-calibrated and temperature-compensated sensor in the industry.
- True digital LED display and trend indicator for each service monitored.
- Illuminated LED display that is visible at an angle or in dim lighting conditions.
- PSI, kPa or BAR display (switch selected).
- Self-diagnostic circuitry with error display for problem identification.
- Highly accurate solid state pressure piezoresistive transducer.
- Adjustable repeat alarm (1 to 60 minutes or off).
- Dry contacts for remote monitoring of High and Low alarm status.
- Modules are factory mounted on a hinged frame assembly for ease of installation and maintenance.
- Field programmable push buttons for adjustment of HI and LOW set-points on display module.
- Available in 1 to 7 display modules.
- Built-in relay for remote annunciator applications.

Installation of Alarm Valve Combo Unit Boxes

The Amico Valve Combo Unit is shipped in one container holding two separate packages. One package contains the Alarm Valve Combo. The other package contains the window and the frame assembly.

1. Recessed Valve Box: anchor the valve box rough-in to the studs so that the front edge will be flush or slightly recessed with the finished wall. The recommended mounting is 66" (1676 mm) from the top of the valve box to the finished floor.

NOTE: The Shutoff Valve handles should be installed to point downstream for pressurized gases.

2. Before brazing, remove all box plugs as they could melt during brazing. Wrap wet rags around the tube extensions next to the valves to prevent overheating and possible damage to the valve seals. Connect copper tubing to the valve extensions (outside the valve box) using brazing methods and materials in accordance with NFPA-99 or CSA Z7396.1-06. Once valve extensions are cool, remove rags.
3. Test the system (per appropriate standards) to ensure that the intended gas and vacuum services are connected to the appropriate lines.

WARNING: Misconnection of the gases could lead to serious or fatal injury to patients. Following the initial installation of shutoff valves, make certain that the intended services are correctly connected to the appropriate service lines.

4. Test the system for leaks (per appropriate standards)

NOTE: Pipe sealants should comply with the requirements of NFPA 99 or CSA Z7396.1-06. Use care to exclude pipe sealants from the valve cavity and from interior tube surfaces exposed to medical gas flow or vacuum service. Properly applied Teflon tape is an alternative to pipe sealants. Check Shutoff Valve handle operation for proper clearance from gauge (if installed).

5. After the wall is finished, remove the window by pulling the ring towards you and attach the aluminum frame to the alarm valve combo unit valve box with the No. 6 metal screws provided. Then put the window back in place.



Maintenance

Operate shutoff valves periodically and repair them, if seals tend to stick or leak. Notify all concerned personnel before shutting off any gas supply.

WARNING: To protect the lives of patients, always notify the appropriate medical facility staff before shutting off the supply of medical gas or vacuum through a shutoff valve. Do not close shutoff valves except in cases of emergency or maintenance.

Clean the exterior of the valve boxes routinely with soap and water. Strong solvents may damage the Lexan window.

Authorized hospital personnel should close shutoff valves in the event of fire, explosion or damage to the pipeline systems or equipment.

In Alarm Valve Combo Unit boxes, the Shutoff Valve handles become accessible after the window has been removed from the valve box.

To remove the window, grasp the ring and pull outwards. Turn valve handle towards you to shut off the flow of gas or vacuum.

Zone Valves have a swingout design body which makes changing the internal components of the ball valve easier.

All valve bodies can be accessed by loosening all bolts and nuts and removing only one bolt, at this point the valve body can be swung out for servicing.

Description of Modules: Common to All Alarms

System Power Supply

The System Power Supply has been pre-installed into the back box assembly. The System Power Supply converts the AC voltage supply to the alarm into two voltages: 5 VDC (regulated) required by the microprocessor hardware and 15 VDC (unregulated) required by the buzzer and the LED's. This unit also contains the main ON/OFF power switch, the transformer, the heat sink, the main fuse and fuse cover, the rectifying circuitry, the terminal blocks and the low voltage DC power cable for connecting this unit to the annunciator module. The System Power Supply can be easily removed and reinstalled by unscrewing it from the back box.

Annunciator Module

The Annunciator Module contains the buzzer, a "Power On" LED as well as the "TEST" and "ALARM MUTE" buttons. The function of the "TEST" button is to verify that the buzzer and all the LED's are in working condition. An alarm will be heard when this button is pushed and all the LED's will light up. When the button is released, the alarm will silence. The "ALARM MUTE" button is used to silence an alarm that has occurred. This module also contains a fail-safe relay that de-energizes when the buzzer is activated. This relay can be used with the Amico remote buzzer, for applications requiring a remote audible alarm (see Appendix B), for connection to another Amico alarm or a building management system.

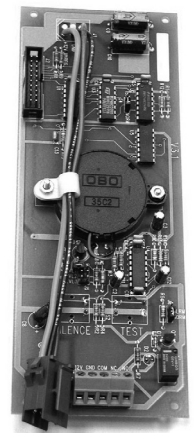

Alarm Valve Display Module

The module provides a digital display of the actual pressure/vacuum of a gas being monitored. In addition, a gas trend indicator bar with High and Low alarms are displayed. The trend bar has two coloured LED's: GREEN for Normal and RED for High and Low conditions.

Each display module contains a gas specific, colour coded label (USA or ISO colours are available). The Display Module is field adjustable for pressure/vacuum settings, repeat alarm and unit of measure. Dry contacts for high and low alarms are available for remote monitoring of each module.



Sensor Module

The Sensor Module contains the transducer which converts the gas/vacuum pressure source into a digital signal that is displayed on the display module. The sensor module shall be housed in an anodized aluminum and nickel-plated brass enclosure to act as an interference barrier. It is also temperature compensated.

Each sensor is clearly labeled and colour coded for the gas or vacuum being monitored. The sensor module contains a gas specific DISS fitting to ensure correct connection of the proper sensor to the respective gas. Each sensor has been factory calibrated by a computer for the specific gas shown on the sensor housing. If it is not connected to the appropriate gas display module, an error message (EO2) will be displayed.



Installation of Alarm

For Local Sensor Only

If the sensors are to be mounted locally (inside the valve box), the pipe stubs must be connected to the pipeline. Using silver-brazing techniques, connect each pipe stub to its appropriate gas or vacuum while ensuring that the bottom of the pipe stub is wrapped with a damp cloth. BE CAREFUL not to damage the DISS check-valve by overheating. When the brazing of pipe stubs has been completed, the system can be pressure tested.

Standing Pressure Test

Perform a standing pressure test on the piping system as per NFPA-99 “Health Care Facilities” or CSA-Z305.1 “Non-flammable Medical Gas Piping Systems”. Inspect all joints for leaks and make certain each gas is piped to a correspondingly labeled gas service.

Frame/Module Assembly

- Step #1 Remove the frame/valve window from its protective box

- Step #2 Attach the Sensor wire to the display module (Sensor +, -)

- Step #3 Close the valve window

Installation of Alarm

CAUTION: The microprocessor circuitry on the alarm valve unit contains sophisticated integrated semiconductors. If it becomes necessary to remove a module, PLEASE hold the boards by the edges. **DO NOT TOUCH** any of the components on the board. Static discharge can cause the modules to malfunction or become damaged.

Sensor

LOCAL (Inside the Back Box)

1. Locate the gas specific sensor module to be installed.
2. In the back box, there are colour coded gas labels located under the DISS Demand check valves. Each label identifies where each sensor module is to be placed.
3. The sensor module contains a gas specific DISS fitting. Push the sensor module hex-nut and nipple adapter up into the demand check-valve. With a wrench, tighten the nut so that it makes a good seal.

NOTE: Pressure on sensors is not to exceed 250 psi for pressure sensors and 30" for vacuum sensors

The sensor can reach pressure up to:

Mid Pressure 0-99 Psi

Hi Pressure 0-249 Psi

Vacuum 0-30" Hg

REMOTE (Outside the Back Box)

1. Connect a Tee (supplied by others) to the pipeline with a 1/4" NPT female connection that will accept the DISS Demand check-valve.
2. Locate the gas specific sensor module to be installed.
3. Thread the DISS Demand check-valve into the correct gas pipeline.
4. The sensor module contains a gas specific DISS fitting. Push the sensor module hex-nut and nipple adapter up into the demand check-valve. With a wrench, tighten the nut so that it makes a good seal.

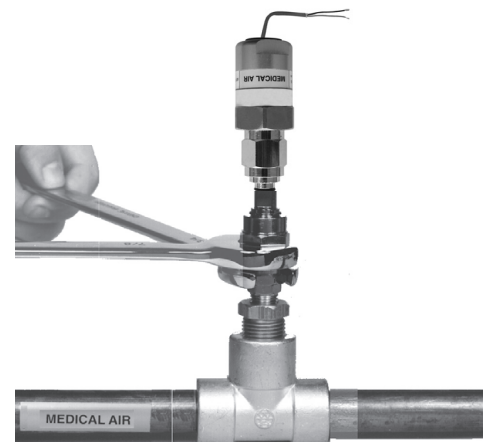

Wiring

System Power Supply

TURN OFF THE POWER SWITCH BEFORE CHANGING ANY MODULES AND/OR DISCONNECTING ANY CABLES, OR ELSE THE FUSE WILL BLOW TO PROTECT THE CIRCUITRY.



1. Ensure that the ON/OFF switch is in the OFF position.
2. Through the top left side of the back box, bring in the AC power wires. Knockouts are provided for making conduit connections to the box. All wiring is to be installed according to local and national codes.
3. Connect the AC power to the terminal blocks as shown in the wiring diagram in Appendices A and F.

Annunciator Module

1. The Annunciator Module has a female receptacle located at the top right side of the board (J1).
2. Connect the DC power cable from the System Power Supply into the receptacle connection located on the annunciator module. The connector is keyed and can only be plugged in one way, (Appendix B).

Sensor Module

LOCAL (Inside the Back Box)

1. The sensor module is provided with a 6"-8" (0.1 m-0.2 m) twisted pair of wires. One wire is red (positive) and the other wire is black (negative). Connect the wires to the display module as shown in Appendix C. Take the red wire from the sensor and attach it to terminal "Sensor +" on the display module. Take the black wire from the sensor and attach it to terminal "Sensor -". The terminal block on the display module is clearly marked for proper connection of the sensor wires.
2. Repeat the above procedures with the remaining sensor modules.

REMOTE (Outside the Back Box)

1. The sensor module is provided with a 6" - 8" (0.1m - 0.2m) twisted pair of wires. Connect the wires to a junction box (not supplied) located near the sensor as per the wiring diagram in Appendix D.
2. Connect a shielded twisted pair cable from the junction box to the back box assembly. Knockouts are provided throughout the alarm back box. Up to 2,500 feet (750 m) of 22 Gauge, shielded twisted pair cable should be used.
3. Connect the red wire from the cable to the terminal on the display module marked "Sensor +". Connect the black wire to terminal "Sensor -" (see Appendix D).
4. Repeat the above procedures with the remaining sensor modules using the wiring diagram in Appendix D.

PLEASE NOTE: When remote sensors are used, a shielded or twisted pair cable is required (BELDEN #8451 or equivalent, supplied by others). Ensure that the proper gas sensor module is connected to its corresponding area display module, otherwise an error message (E02) will be displayed on the Display module.

Annunciator Module

Noise Level Control

Factory Default: 80 Decibels

To decrease noise level:

1. Locate jumper at J5. Move jumper to:
LVL1 = 90 dBa.
LVL2 = 80 dBa.
LVL3 = 70 dBa.

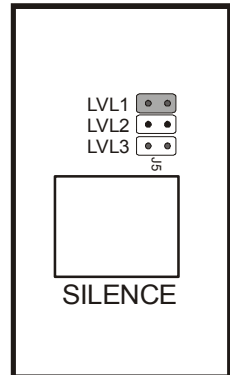

Control of Remote Alarm Buzzer

Factory Default: Normal Condition

To silence remote alarm buzzer when silencing the annunciator module:

1. Locate jumper at J6. Move jumper to:

NORM =

Remote alarm buzzer will silence when annunciator module is silenced.

ALRM =

Remote alarm will not silence when annunciator module is silenced.

The buzzer will only silence when an alarm condition has been cleared.

Please refer to Appendix B.

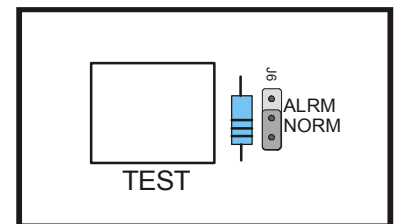

Steps to Re-Calibrate the Sensor from Area Module v4.0

1. Turn on Alarm
2. Set switches #8 and #10 the OFF position
3. Set switches #5 and #6 the ON position
4. The display will show the current reading of the pressure
5. Adjust the calibration, using the "UP" and "DOWN" push buttons, to the desired value.
6. Set switches #5 and #6 the OFF position
7. Turn on #10 if AIMS is connected (do not turn on #8)

When you have completed step #7, the display module will automatically go into "RESET" mode. This will store the data that you entered.

The Display Module

A dip-switch is located on the back of the display module which is used to identify the gas of the display module. The dip-switch contains ten switch settings.

Pressure Only

Factory Default:

High = 60 Psi, Low = 40 Psi

Repeat time = 30 min.

High Pressure/Nitrogen

Factory Default:

High = 195 Psi, Low = 140 Psi

Repeat time = 30 min.

During programming, the "Trend Bar" will flash!

1. Set switch #6, #7 and #8 to the ON position.

2. The LED will display (HI-), followed by the current set point. Indicating that the system is ready to accept a new High set point. Adjust set point, using the "UP" and "DOWN" push buttons, to the desired value.

3. Set switch #7 to the OFF position.

4. The LED will display (LO-), followed by the current set point. Indicating the system is ready to accept a new Low set point. Adjust set point, using the "UP" and "DOWN" push buttons, to the desired value.

5. Set switch #8 to the OFF position.

6. The LED will display (I-I-), followed by the current set point. Indicating the system is ready to accept a new Repeat Time set point. Adjust set point using the "UP" and "DOWN" push buttons, to the desired value. [(Display dd=Disabled) Range from 1 to 60 Minutes]

7. Set switch #6 to the OFF position.

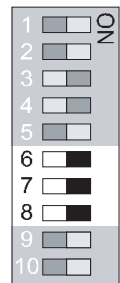

Compact Alarm Board

Dip-Switch

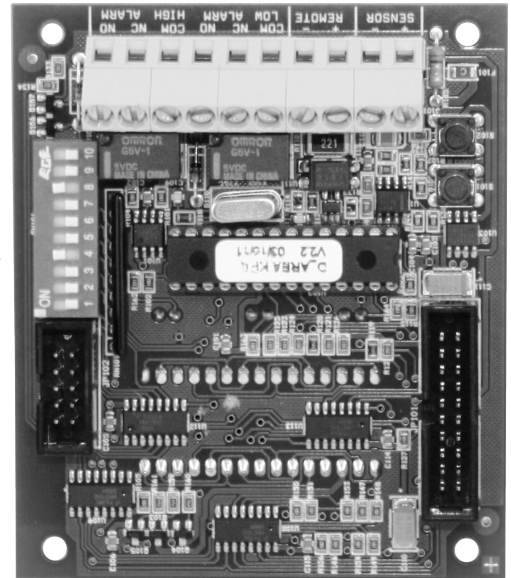

When you have completed step #7, the display module will automatically go into "RESET" mode. This will store the data that you entered.

"UP" and "DOWN" Push Button

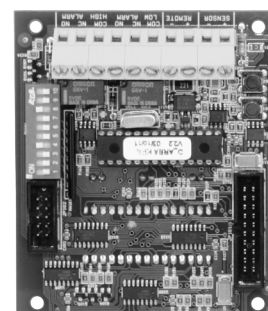

PSI / kPa / BAR Selection

Factory Default - PSI

For PSI mode, set the switch #4 to the ON position. The LED PSI indicator located next to the gas pressure reading will illuminate.

For kPa mode, set the switch #4 to the OFF position and switch #9 to the ON position. The LED kPa indicator located next to the gas pressure reading will illuminate.

For BAR set the switch #4 to the OFF and the switch #9 to the OFF position. The LED kPa indicator located next to the gas pressure reading will illuminate. (There is no separate indicator for BAR).

Vacuum Only

Vacuum alarm set-point adjustment

Factory Default:

High = 30"Hg, Low = 12"Hg

Repeat time = 30 min.

During programming, the "Trend Bar" will flash!

1. Set switch #6, #7 and #8 to the ON position.
2. The LED will display (HI-), followed by the current set point. Indicating the system is ready to accept a new High set point. Do not adjust this set point since the High set point is not used.
3. Set switch #7 to the OFF position.
4. The LED will display (LO-), followed by the current set point. Indicating the system is ready to accept a new Low set point. Adjust set point, using the "UP" and "DOWN" push buttons, to the desired value.
5. Set switch #8 to the OFF position.
6. The LED will display (I-I-), followed by the current set point. Indicating the system is ready to accept a new Repeat Time set point. Adjust set point using the "UP" and "DOWN" push buttons, to the desired value. [(Display dd=Disabled) Range from 1 to 60 Minutes].
7. Set switch #6 to the OFF position.

When you have completed step #7, the display module will automatically go into "RESET" mode. This will store the data that you entered.

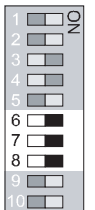
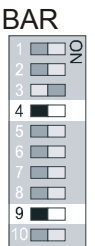
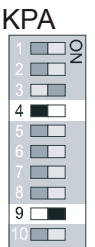
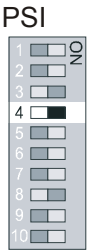

InchHg / kPa / BAR Selections

Factory Default - InchHg

For InchHg mode, set the switch #4 to the ON position. The LED indicating InHg located next to the vacuum source reading will illuminate.

For kPa mode, set the switch #4 to the OFF position and the switch #9 to the ON position. The LED indicating kPa located next to the vacuum source reading will illuminate.

For BAR mode, the kPa indicating source must be changed to BAR by use of a label. Set the switch #4 to the OFF and the switch #9 to the OFF position. The LED indicating BAR located next to the vacuum source reading will illuminate.

Common Settings For Pressure and Vacuum

Repeat Alarm Enable/Disable

Factory Default - Disable

Disable

Set switch #5 to the OFF position to disable the repeat alarm.

NOTE: When the repeat alarm function is disabled, the alarm will not repeat.

Enable

Enable Mode: (Factory Default 30 min, when enabled).

Set switch #5 to the ON position.

PLEASE NOTE: The module with the lowest set Repeat Time is the one that controls the Repeat Time. For example, if one module is set for 5 minutes and one for 30 minutes and both are Repeat Alarm enabled, the alarm will now repeat every 5 minutes.

Setting Factory Default

To quickly reset the module (Pressure or Vacuum) to the factory default settings as follows:

- Pressure: High set-point 60 Psi, Low set-point 40 Psi.
- Nitrogen and HP Air: High set-point 195 Psi, Low set-point 140 Psi.
- Vacuum: Low set-point 12 inchHg.
- No Repeat alarm, but set for 30 min.

1. Set switch #8 to the ON position.
2. Turn the power off (wait 5 seconds) then back on.
3. Set switch #8 to the OFF position.

The module is now in the default mode.

InchHg

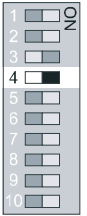

KPA

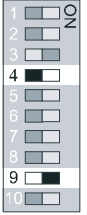

BAR

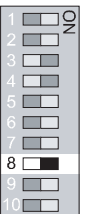
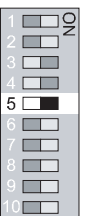
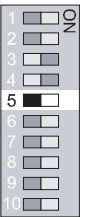
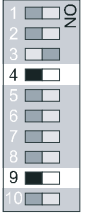

Setting Gas Identification Switches

PLEASE NOTE: DO NOT tamper with switches #1, 2 and 3 on the dip-switch. Tampering with these positions will result in an error message being displayed (E02) and will disable the electrical interlock from the gas specific sensor.



Changes to these switches should only be done by properly trained personnel, when circuit boards have to be changed in the field.

Switches #1, #2 and #3 are used for the gas identification of the display module. These will be set at the factory and should not be tampered with in the field.

Chart of Gas Specific Settings of Dip-Switches

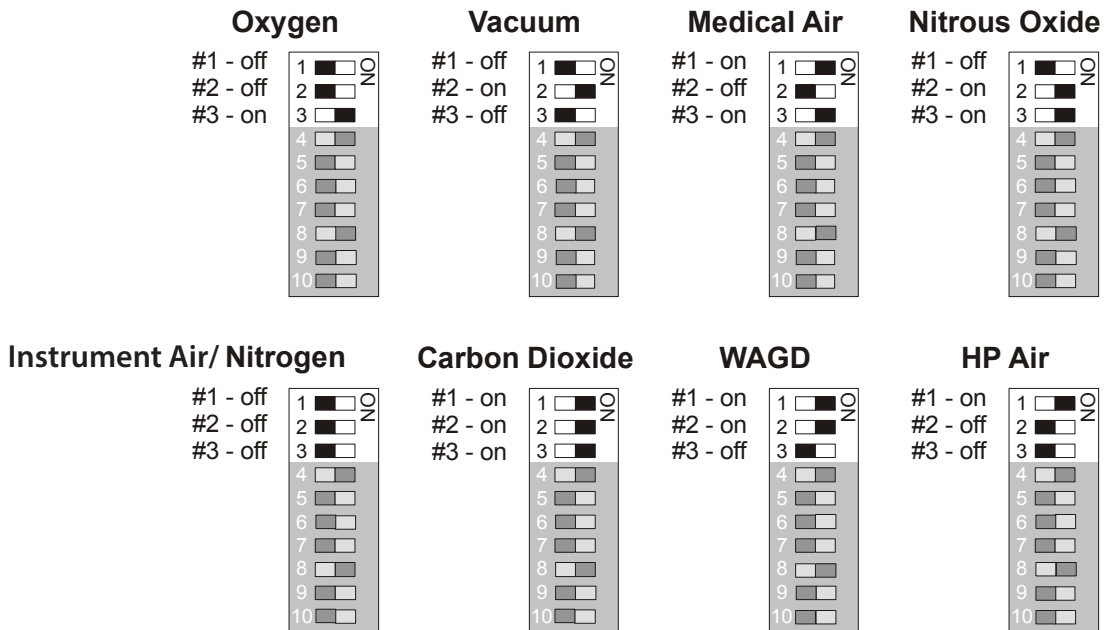

Troubleshooting Guide

Symptom	Cause	Corrective Action
An error code appears on one or more display modules	The microprocessor detected a fault and has shut down	Turn power switch to OFF position. Wait for at least 5 seconds before turning on the power. The program will reset itself.
	Faulty wire connection between the sensor and display module	Check error codes at the end of this section.
No power on the alarm (no LED's illuminated)	AC power not available	Ensure that the ON/OFF switch on the power supply module is turned ON AC wiring not connected Check the building electrical breaker to ensure that the power is ON Check the voltage at the terminal block above the transformer. Ensure that 115 VAC or 220 VAC is being supplied.
	Fuse is blown	Check the fuse. The fuse is located on the upper right corner of the system power supply. Replace the fuse if it is defective. See Appendix A.
	DC power plug not connected to the annunciator module	Ensure that the DC power plug is firmly in its socket on the annunciator module. Replace System Power Supply unit if all the above steps fail to resolve the problem.
	Defective ribbon cable	Replace the ribbon cable

Troubleshooting Guide

Symptom	Cause	Corrective Action																
Power light on the annunciator module is ON but LED's on other modules are not on	DC power cable is not connected to the annunciator module	<p>Ensure that the DC power cable is firmly in its socket on the annunciator module</p> <p>Ensure that the module(s) on the Frame/Module assembly are all connected to the ribbon-cable</p> <p>Replace the annunciator module</p>																
No audible alarm and LED's are not illuminating	DC power cable is disconnected or loose	<p>Ensure that the DC power cable from the system power supply is connected to the annunciator module snugly</p> <p>Depress "TEST" button. If the LED's come on and there is no audible alarm, replace the annunciator module. If this does not work, try solutions to problem #2.</p>																
Audible signal will not silence	Faulty display module	Disconnect the ribbon cable from the back of the faulty display module(s) and replace the module(s)																
	Connection of the DC power cable from system power supply to annunciator module is loose	Disconnect the DC power cable from the annunciator module and then reconnect. If the audible signal still persists, replace the System Power Supply unit.																
	Faulty annunciator module	Replace annunciator module																
Alarm condition exists but LED's are not illuminating	Display module not properly calibrated	<p>Ensure that the system was properly ordered.</p> <p>Factory default settings:</p> <table border="0"> <tr> <td colspan="2">Mid Pressure:</td> </tr> <tr> <td>Hi Pressure</td> <td>60 Psi</td> </tr> <tr> <td>Low Pressure</td> <td>40 Psi</td> </tr> <tr> <td colspan="2">Vacuum:</td> </tr> <tr> <td>Low Vacuum</td> <td>12 inHg</td> </tr> <tr> <td colspan="2">High Pressure:</td> </tr> <tr> <td>Hi: Nitrogen & Air</td> <td>195 Psi</td> </tr> <tr> <td>Low: Nitrogen & Air</td> <td>140 Psi</td> </tr> </table> <p>If calibration is required, refer to setting HIGH and LOW calibration procedure on page 13-14</p>	Mid Pressure:		Hi Pressure	60 Psi	Low Pressure	40 Psi	Vacuum:		Low Vacuum	12 inHg	High Pressure:		Hi: Nitrogen & Air	195 Psi	Low: Nitrogen & Air	140 Psi
	Mid Pressure:																	
Hi Pressure	60 Psi																	
Low Pressure	40 Psi																	
Vacuum:																		
Low Vacuum	12 inHg																	
High Pressure:																		
Hi: Nitrogen & Air	195 Psi																	
Low: Nitrogen & Air	140 Psi																	
	Faulty display module	Replace the display module.																

Troubleshooting Guide

Symptom	Cause	Corrective Action
Gas reading incorrect	Loose connection of DISS fittings	Ensure that the sensor module is properly connected to the DISS demand check-valve
	Sensor module is not properly wired to the display module	Ensure that the sensor module is properly wired to the display module by using wiring diagram in Appendix C or D
	Defective sensor or requires calibration	Replace the sensor module
	The ribbon cable is not properly connected to the display module	Pull out the ribbon cable and connect it back in again, while ensuring that it is seated properly
	Defective display module	Replace the display module

Error Code Messages on the Display Module

System	Cause	Corrective Action	Page
E01	No sensor is connected.	Connect a sensor	28/29
E02	Sensor and Display Module mismatched.	Ensure that the Sensor and Display Module are for the same gas	16
E03	The High set-point was set below the Low set-point or vice versa.	Recalibrate the High and Low setpoint to proper values	13/14
E04	Incorrect type of Sensor connected (e.g. 250 psi sensor on a 100 psi range)	Connect the correct Sensor to the matching Display Module	
E06	Cable between the sensor and display module shorted out or reversed polarity	Reverse polarity or replace cable if defective	28/29
E07	Out of calibration / Sensor not reading gas	Replace the sensor module	28/29

Model Numbers

Alarm Valve Combo Unit

AVCLN-XXGXXGXXGXXGXXGXXG

The "L" Defines the Language:

U = English (NFPA)
E = English (CSA/ISO)
F = French (CSA/ISO)
S = Spanish (NFPA)

The "N" Defines the # of Valves:

1 = 1 Valves
2 = 2 Valves
3 = 3 Valves
4 = 4 Valves
5 = 5 Valves
6 = 6 Valves

The "G" Defines the Gas:

O = Oxygen
A = Medical Air
V = MedVac
2 = Nitrous Oxide
N = Nitrogen
C = Carbon Dioxide
W = WAGD (NFPA)
E = AGSS (ISO)
I = Instrument Air

Replace "XX" with the Required Valve Size:

05 = 1/2" [1.3 cm]
07 = 3/4" [1.9 cm]
10 = 1" [2.5 cm]
12 = 1-1/4" [3.2 cm]
15 = 1-1/2" [3.8 cm]
20F = 2" [5.1 cm]

Notes:

- The power supply requires 1 gang per box.
 - Example: English, 3 valves, 1/2" Oxygen, 3/4" Medical Air and 1-1/4" Medical Vacuum. Will be in a 4 gang box, not a 3 gang: AVCU3-05O05A12V
- The 1-1/2" valve will have an empty space above the valve.
 - Example: a box with a 1/2" Oxygen, 3/4" Medical Air and 1-1/2" Medical Vacuum and a power supply will require a 5 gang box not a 4 gang box.
- The 2" valve will be assembled in a 6-1/2" deep box and shall accommodate up to a maximum of four gases. The 2" valve shall be positioned on the bottom of the assembly. The height measurements of the 6-1/2" deep valve box are the same as the 3-7/8" deep valve box. When comparing height measurements, consider the gap above the 2" valve.
 - Example: a valve box with 1/2" valve, 2" valve and a power supply would be in a 3 gang, 6-1/2" deep box, which would be the same height as the 4 gang, 3-7/8" valve box.
- 2-1/2" and 3" valve assemblies are only offered as singles.

Model Numbers

Alarm Valve Combo Unit

AVCHLN-XXGXXGXXGXXGXXGXXG

H = Horizontal

The "L" Defines the Language:

U = English (NFPA)
E = English (CSA/ISO)
F = French (CSA/ISO)
S = Spanish (NFPA)

The "N" Defines the # of Valves:

1 = 1 Valves
2 = 2 Valves
3 = 3 Valves
4 = 4 Valves
5 = 5 Valves
6 = 6 Valves

The "G" Defines the Gas:

O = Oxygen
A = Medical Air
V = MedVac
2 = Nitrous Oxide
N = Nitrogen
C = Carbon Dioxide
W = WAGD (NFPA)
E = AGSS (ISO)
I = Instrument Air

Replace "XX" with the Required Valve Size:

05 = 1/2" [1.3 cm]
07 = 3/4" [1.9 cm]
10 = 1" [2.5 cm]
12 = 1-1/4" [3.2 cm]
15 = 1-1/2" [3.8 cm]
20F = 2" [5.1 cm]

Notes:

- The power supply shall be located on the right side of the assembly. For any combinations containing a 2" valve or larger, it will have the power supply on the left side of the assembly.
- Valves are to be assembled vertically, with medical gas flow direction from the bottom to the top.
- The 2-1/2" and 3" valve assemblies are only offered as singles.

Spare Parts Numbers

Model Number	Description
A2P-ANNU-CB	ANNUNCIATOR CIRCUIT BOARD ASSEMBLY
A2P-POWER-V2	POWER SUPPLY MODULE ALERT-2
A2P-SENS-E-AIR	SENSOR MODULE ISO-AIR ENG. ALERT-2
A2P-SENS-E-CO2	SENSOR MODULE ISO-CO2 ENG. ALERT-2
A2P-SENS-E-EVA	SENSOR MODULE ISO-EVA ENG. ALERT-2
A2P-SENS-E-N2O	SENSOR MODULE ISO-N2O ENG. ALERT-2
A2P-SENS-E-NIT	SENSOR MODULE ISO-NIT ENG. ALERT-2
A2P-SENS-E-OXY	SENSOR MODULE ISO-OXY ENG. ALERT-2
A2P-SENS-E-VAC	SENSOR MODULE ISO-VAC ENG. ALERT-2
A2P-SENS-U-AIR	SENSOR MODULE USA-AIR ENG. ALERT-2
A2P-SENS-U-OXY	SENSOR MODULE USA-OXY ENG. ALERT-2
A2P-SENS-U-VAC	SENSOR MODULE USA-VAC ENG. ALERT-2
A2P-SENS-U-WAG	SENSOR MODULE USA-WAG ENG. ALERT-2
A2P-SENS-U-IAR	SENSOR MODULE USA-INSTRUMENT AIR ALERT-2
A2P-AVCDIS-CB	ALARM VALVE COMBO CIRCUIT BOARD ASS. -ALL GASES
A2P-AVCDIS-E-AIR	ALARM VALVE COMBO DIS. MODU ISO-AIR ENG.
A2P-AVCDIS-E-OXY	ALARM VALVE COMBO DIS. MODU ISO-OXY ENG.
A2P-AVCDIS-E-VAC	ALARM VALVE COMBO DIS. MODU ISO-VAC ENG.
A2P-AVCDIS-E-NIT	ALARM VALVE COMBO DIS. MODU ISO-NIT ENG.
A2P-AVCDIS-E-N2O	ALARM VALVE COMBO DIS. MODU ISO-N2O ENG.
A2P-AVCDIS-E-CO2	ALARM VALVE COMBO DIS. MODU ISO-CO2 ENG.
A2P-AVCDIS-E-AGS	ALARM VALVE COMBO DIS. MODU ISO-AGS ENG.
A2P-AVCDIS-U-OXY	ALARM VALVE COMBO DIS. MODU USA-OXY ENG.
A2P-AVCDIS-U-AIR	ALARM VALVE COMBO DIS. MODU USA-AIR ENG.
A2P-AVCDIS-U-VAC	ALARM VALVE COMBO DIS. MODU USA-VAC ENG.
A2P-AVCDIS-U-WAG	ALARM VALVE COMBO DIS. MODU USA-WAG ENG.
A2P-AVC-MYLA-E-O	ALARM VALVE COMBO MYLAR ENG. OXY ISO
A2P-AVC-MYLA-E-A	ALARM VALVE COMBO MYLAR ENG. AIR ISO
A2P-AVC-MYLA-E-V	ALARM VALVE COMBO MYLAR ENG. VAC ISO
A2P-AVC-MYLA-E-N	ALARM VALVE COMBO MYLAR ENG. NIT ISO
A2P-AVC-MYLA-E-2	ALARM VALVE COMBO MYLAR ENG. N2O ISO
A2P-AVC-MYLA-E-C	ALARM VALVE COMBO MYLAR ENG. CO2 ISO
A2P-AVC-MYLA-E-E	ALARM VALVE COMBO MYLAR ENG. AGS ISO
A2P-AVC-MYLA-U-O	ALARM VALVE COMBO MYLAR ENG. OXY NFPA
A2P-AVC-MYLA-U-V	ALARM VALVE COMBO MYLAR ENG. VAC NFPA
A2P-AVC-MYLA-U-A	ALARM VALVE COMBO MYLAR ENG. AIR NFPA
A2P-AVC-MYLA-U-W	ALARM VALVE COMBO MYLAR ENG. WAG NFPA
A2X-AVC-RIBBON2	2 STN RIB CABLE FOR ALRM/VALVE COMBO
A2X-AVC-RIBBON3	3 STN RIB CABLE FOR ALRM/VALVE COMBO
A2X-AVC-RIBBON4	4 STN RIB CABLE FOR ALRM/VALVE COMBO

Spare Parts Numbers

Model Number	Description
A2X-AVC-RIBBON5	5 STN RIB CABLE FOR ALRM/VALVE COMBO
A2X-AVC-RIBBON6	6 STN RIB CABLE FOR ALRM/VALVE COMBO
A2X-AVC-RIBBON7	7 STN RIB CABLE FOR ALRM/VALVE COMBO
A2X-AVC-DVPLATE	DIVIDER PLATE FOR 1GAS ALARM VALVE COMBO
A2X-AVC-DVPLAT2	DIVIDER PLATE FOR 2GAS ALARM VALVE COMBO
A2X-AVC-DVPLAT3	DIVIDER PLATE FOR 3GAS ALARM VALVE COMBO
A2X-AVC-DVPLAT4	DIVIDER PLATE FOR 4GAS ALARM VALVE COMBO
A2X-AVC-DVPLAT5	DIVIDER PLATE FOR 5GAS ALARM VALVE COMBO
A2X-AVC-DVPLAT6	DIVIDER PLATE FOR 6GAS ALARM VALVE COMBO
A2X-AVC-BRKT-2F	P/S COVER FOR ALARM VALVE COMBO
A2X-AVC-PLT-02N	DIVIDER PLATE FOR ALARM VALVE COMBO
A2X-P-SW-AVCCAP	ALARM VALVE COMBO KEYCAP - GRAY
S-DIS-KIT-OXY	DISS DEMAND CHECK, NUT & NIPPLE – OXY
S-DIS-KIT-AIR	DISS DEMAND CHECK, NUT & NIPPLE – AIR
S-DIS-KIT-VAC	DISS DEMAND CHECK, NUT & NIPPLE – VAC
S-DIS-KIT-N2O	DISS DEMAND CHECK, NUT & NIPPLE – N2O
S-DIS-KIT-NIT	DISS DEMAND CHECK, NUT & NIPPLE – NIT
S-DIS-KIT-CO2	DISS DEMAND CHECK, NUT & NIPPLE – CO2
S-DIS-KIT-EVA	DISS DEMAND CHECK, NUT & NIPPLE – EVA
S-DIS-DEMC-AIR	DISS DEMAND CHECK VALVE 1/4"MNPT - AIR
S-DIS-DEMC-OXY	DISS DEMAND CHECK VALVE 1/4"MNPT - OXY
S-DIS-DEMC-VAC	DISS DEMAND CHECK VALVE 1/4"MNPT - VAC
S-DIS-DEMC-N2O	DISS DEMAND CHECK VALVE 1/4"MNPT – N2O
S-DIS-DEMC-NIT	DISS DEMAND CHECK VALVE 1/4"MNPT - NIT
S-DIS-DEMC-CO2	DISS DEMAND CHECK VALVE 1/4"MNPT – CO2
S-DIS-DEMC-EVA	DISS DEMAND CHECK VALVE 1/4"MNPT - EVA

Dimensions

Vertical Alarm Valve Combo Unit

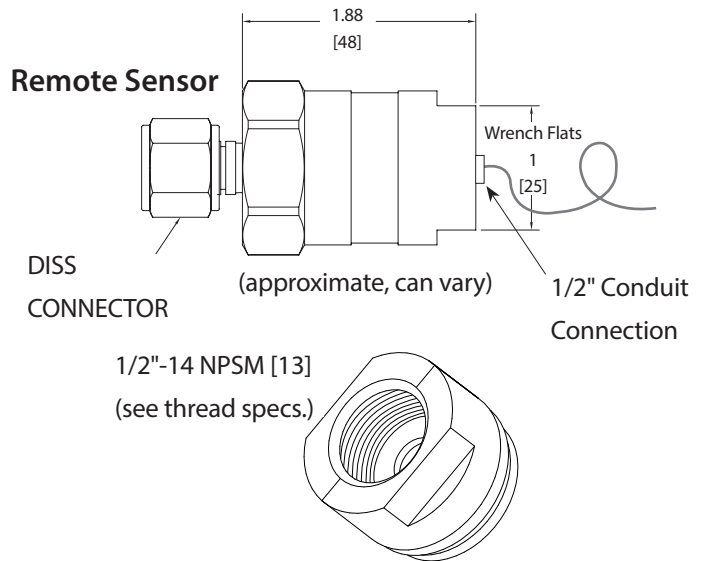
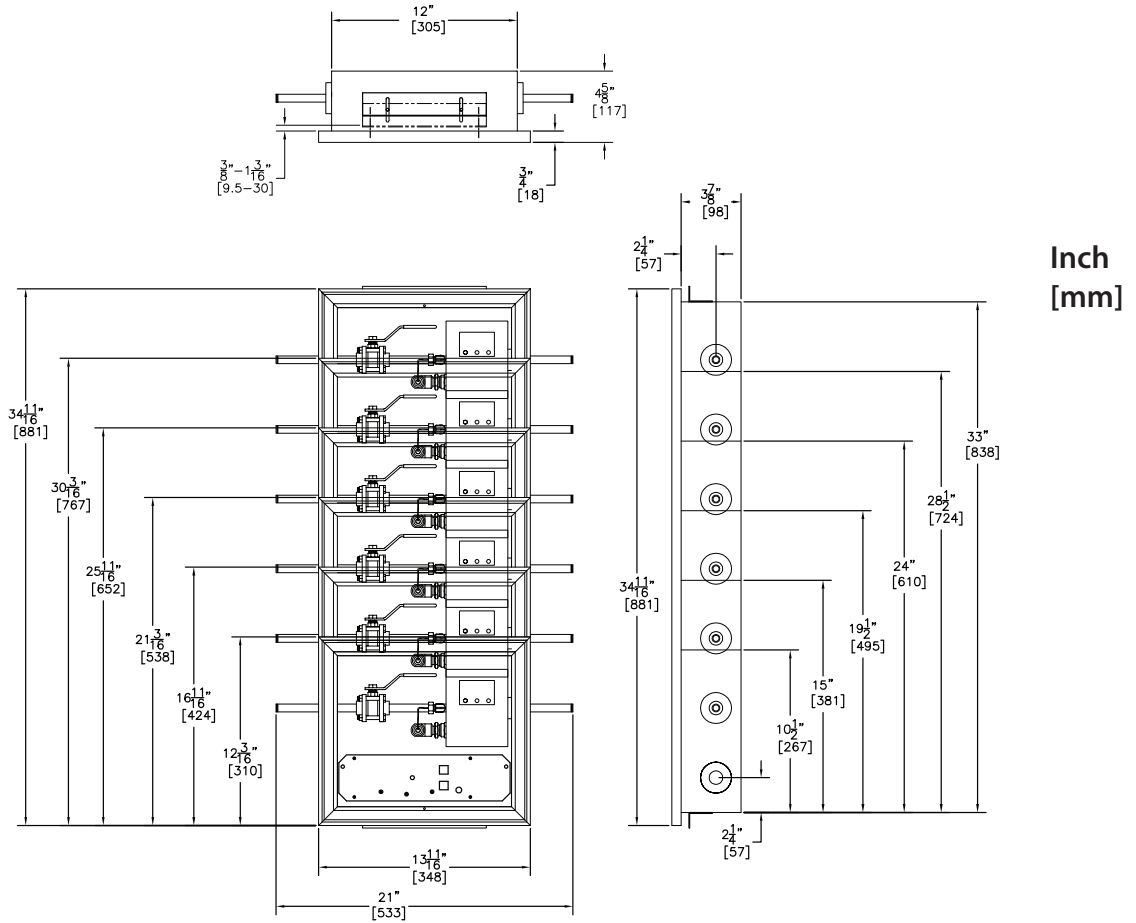

Dimensions

Horizontal Alarm Valve Combo Unit

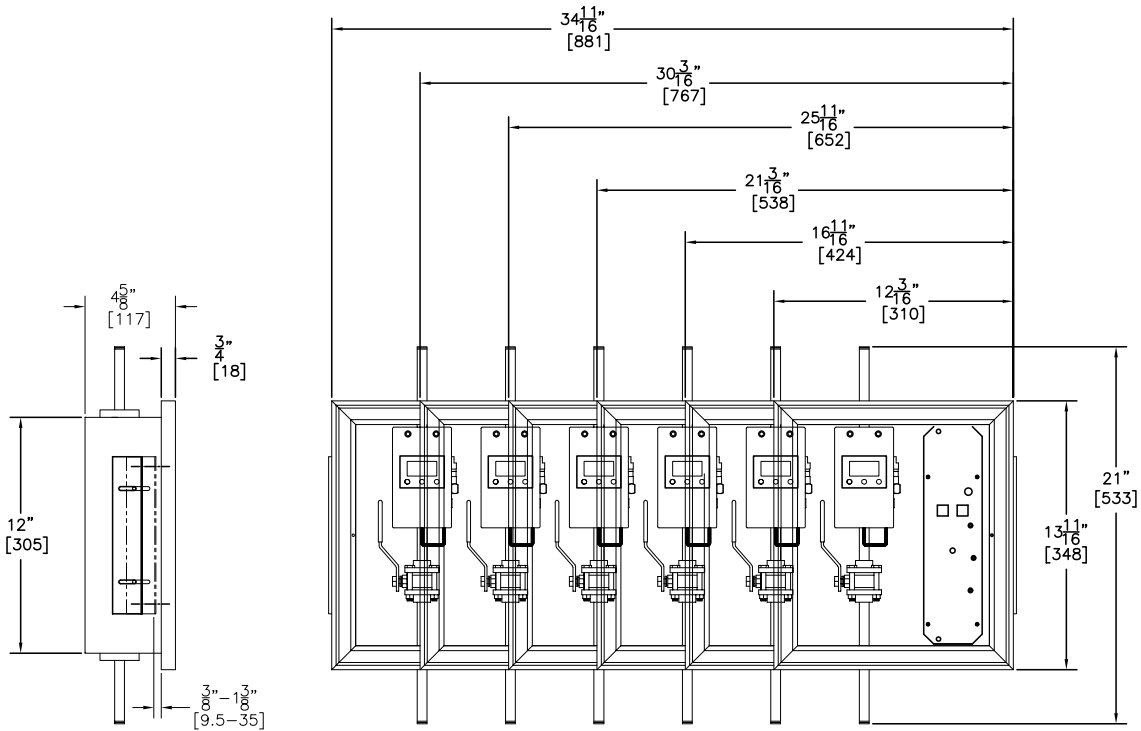

Inch
[mm]

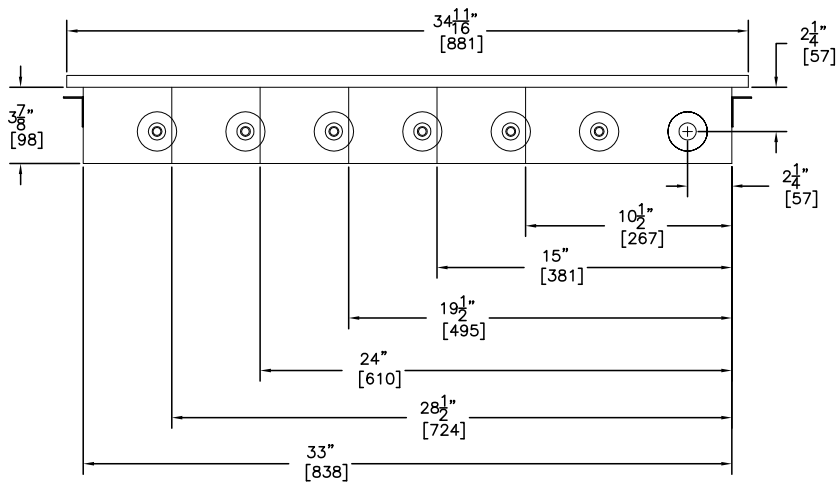

Remote Sensor

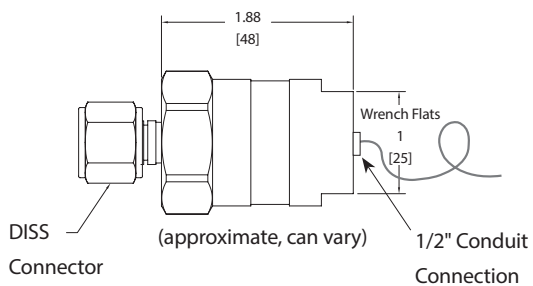

1/2"-14 NPSM [13]
(see thread specs.)

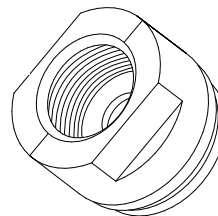

Appendix A

Wiring Diagram – Auto-Switching Power Supply

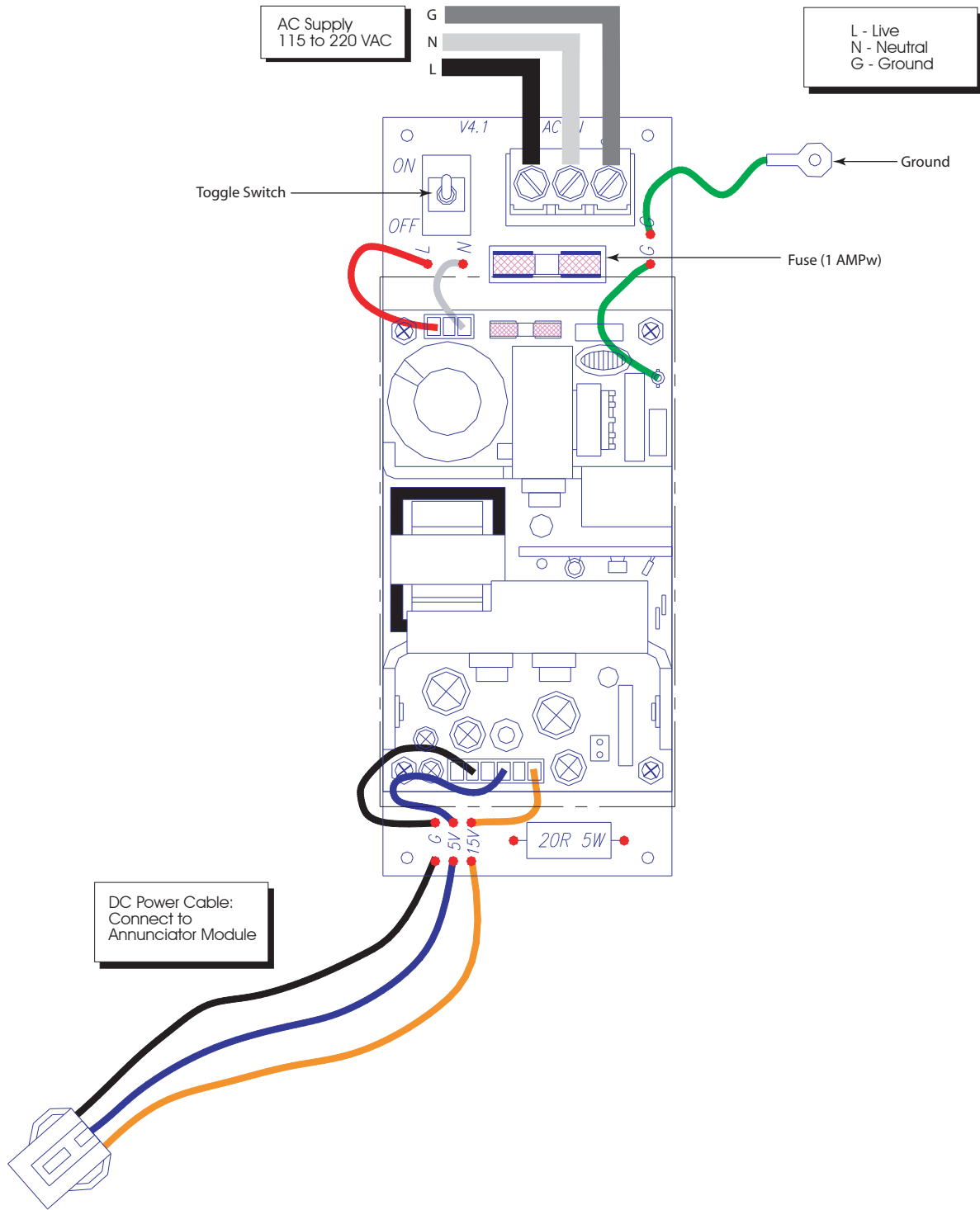

Appendix B

Wiring Diagram – Annunciator

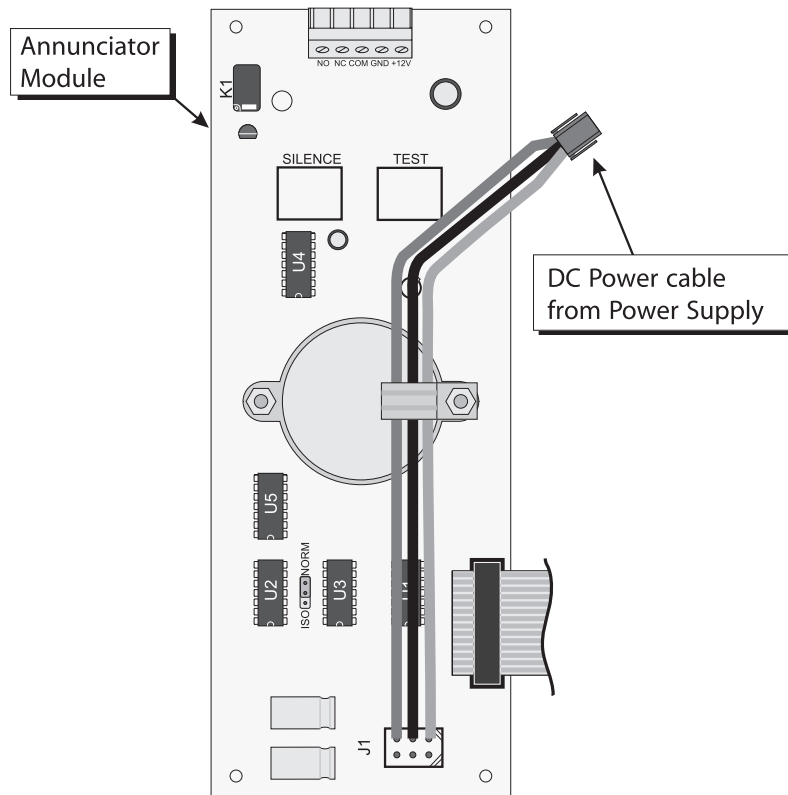
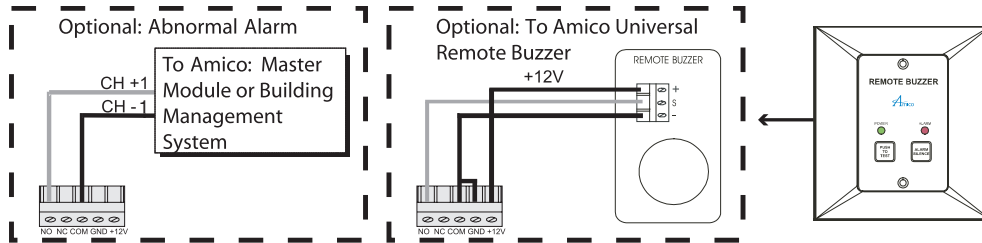

Appendix C

Wiring Diagram – Alarm Valve Combo Unit

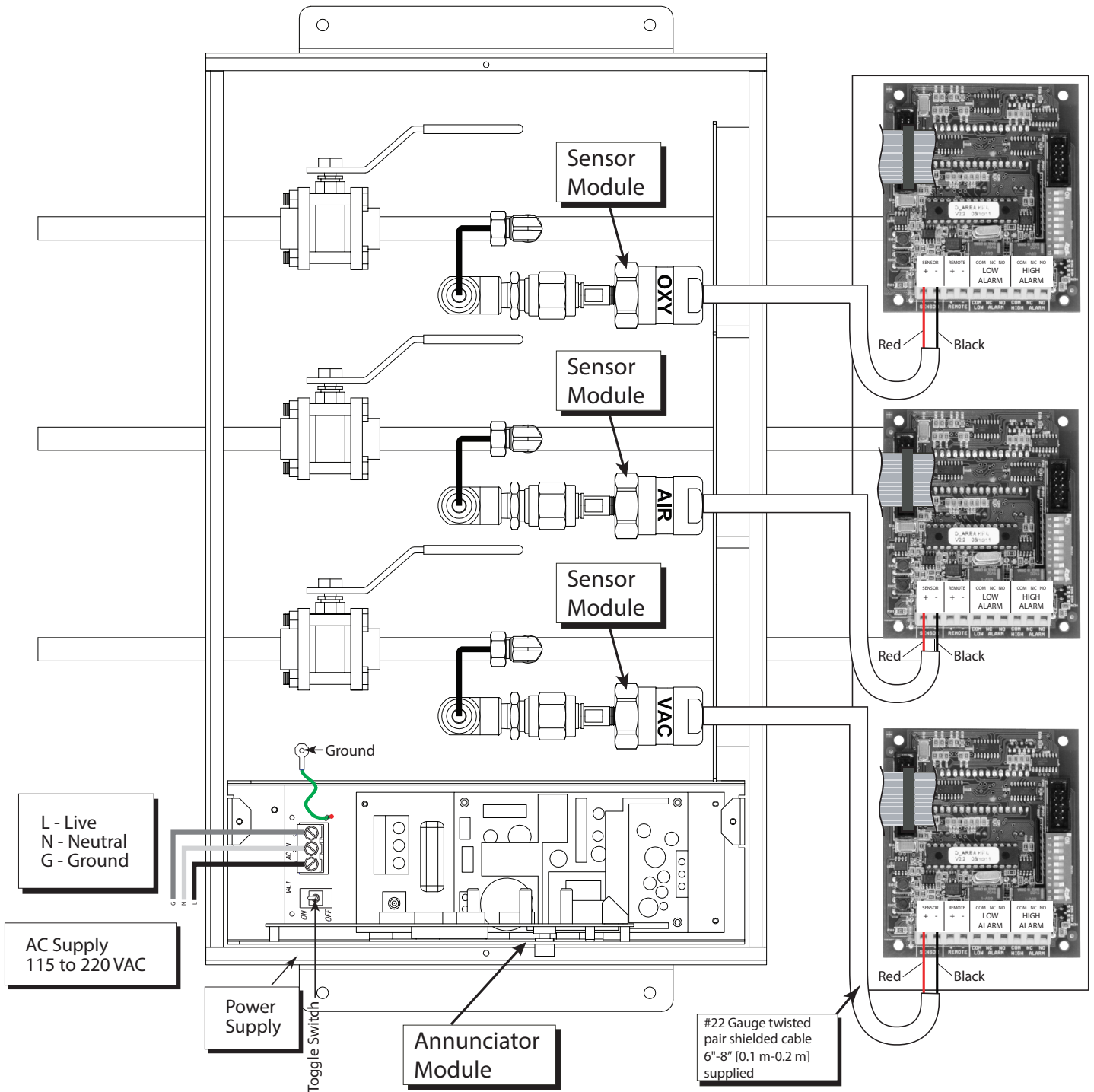

Appendix D

Wiring Diagram – Remote Alarm Valve Combo Unit

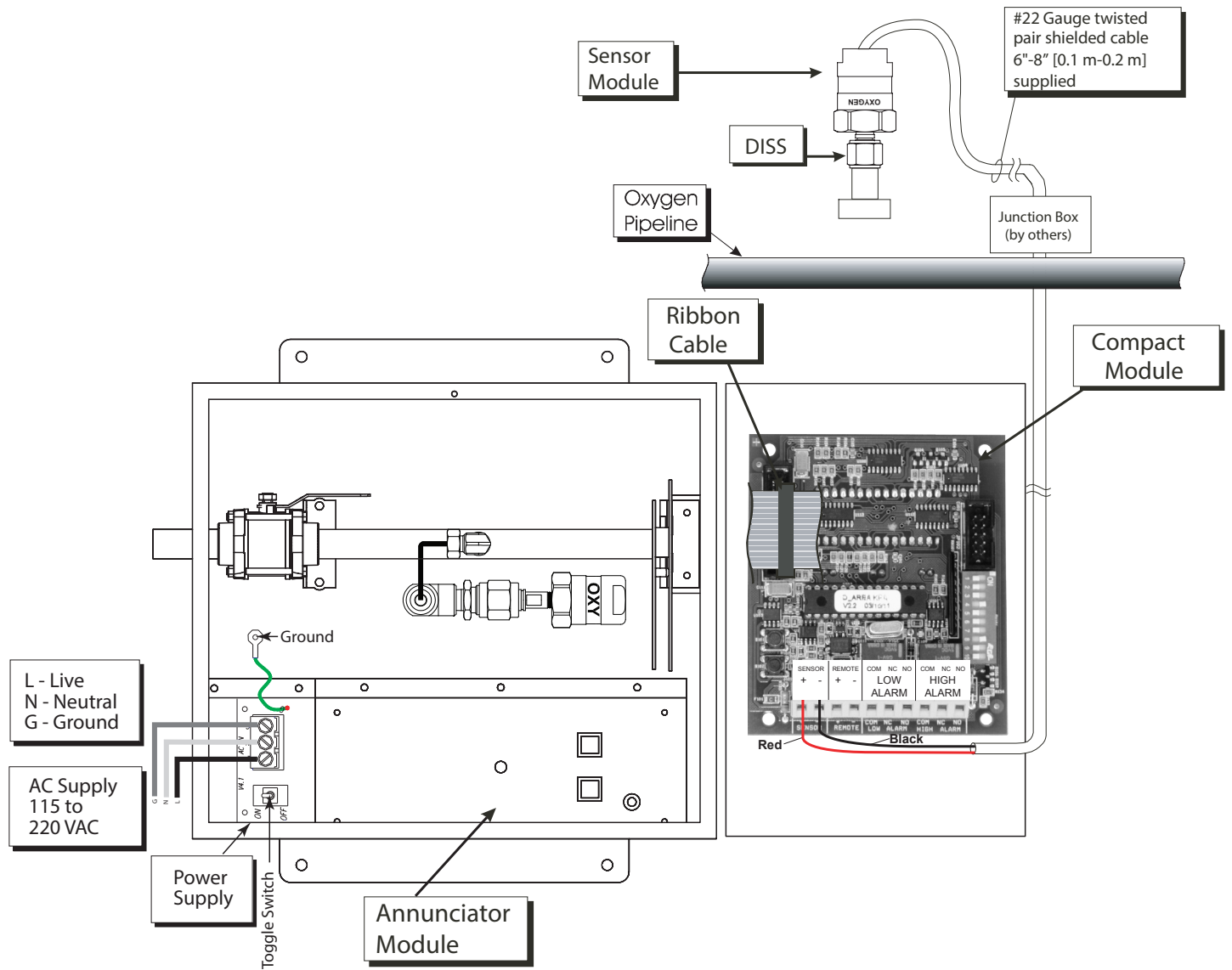

Appendix E

Wiring Diagram - Alarm Valve Combo Unit to Master Module

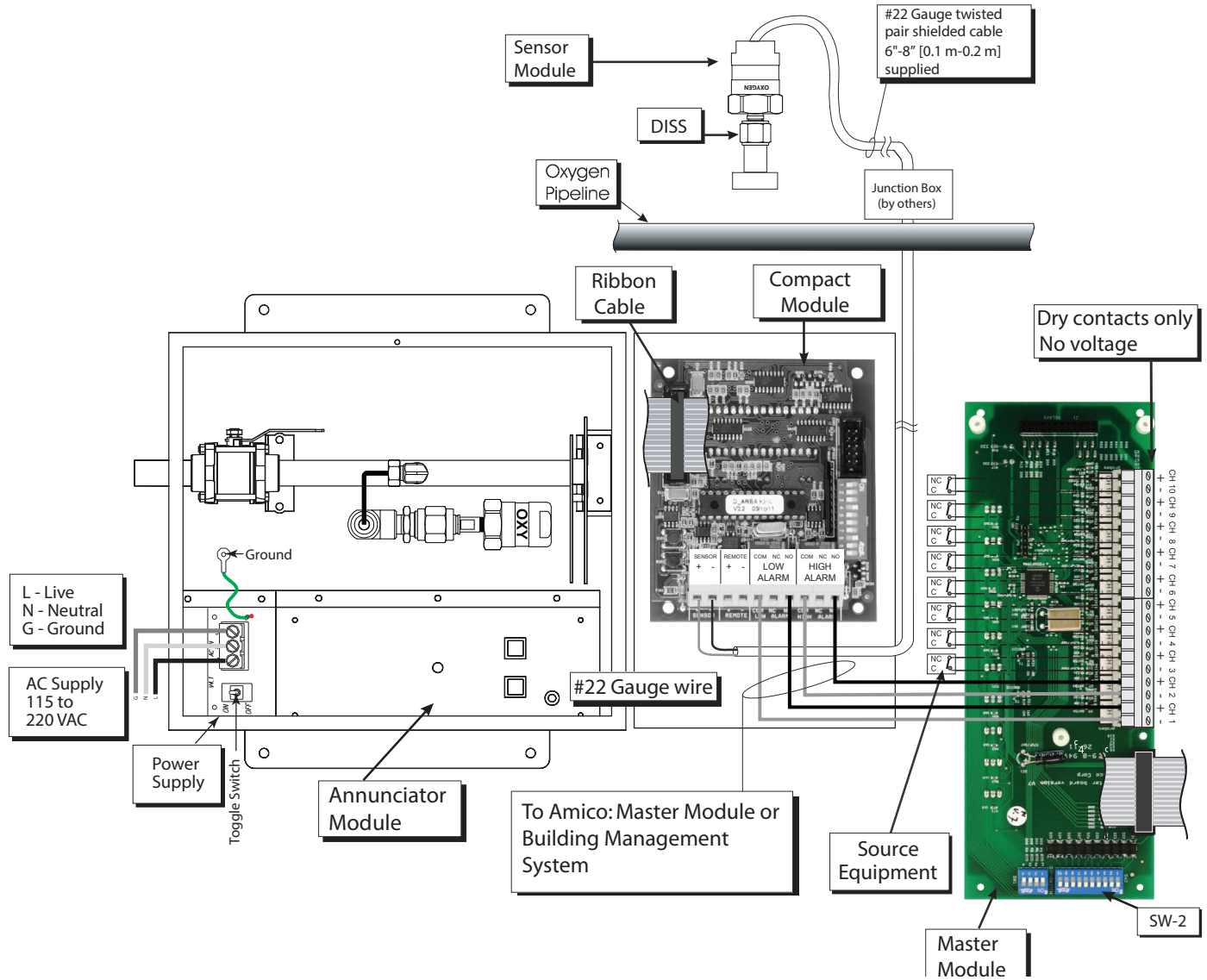

Note

Version 3 and 4: Jumper any unused points on the Master module

Version 4: Turn OFF dip-switches for any unused points (location SW-2)

Appendix F

Technical Specifications

Supply Voltage: 115 to 220 VAC - 50 to 60 Hz

Current Draw: 1 Amp. Max.

Fuse (1/4 * 1-1/4): Fast Blow 1 Amp.

Cable Requirements

AVC Display Module to Remote Sensor:

Distance: Maximum 2,500 feet (750 m)

Cable: Belden # 8451 or equivalent.
#22 gauge shielded, twisted pair (For multiple sensors a multi-conductor shielded twisted pair cable should be used).

Signal:	30 VDC	-	1.0 Amps.
	60 VDC	-	0.3 Amps.
	125 VAC	-	0.5 Amps.

AVC Display Module to Master Module

Distance: Maximum 10,000 feet (3,000 m)

Cable: Minimum #22 gauge wire (does not have to be shielded, twisted pair)

Signal: 5 VDC, < 5 μ A

www.amico.com

Amico Corporation | www.amico.com

85 Fulton Way, Richmond Hill
Ontario, L4B 2N4, Canada

71 East Industry Court, Deer Park
NY 11729, U.S.A

Toll Free Tel: 1.877.462.6426
Toll Free Fax: 1.866.440.4986
Tel: 905.764.0800
Fax: 905.764.0862
Email: info@amico.com

