

Operating & Maintenance Manual

Alert-3 LCD Alarm v2.0



Contents

User Responsibility	3
Introduction	3 - 4
Features	
Description of the Alarm	5 - 6
Shipment Details	5
The Alarm Back Box	5
The Frame/Module Assembly	5
System Power Supply	6
LCD Module	6
Sensor Module	6
Installation Guide	7 - 11
The Alarm Back Box	6
For Local Sensor Only	6
Standing Pressure Test	6
Sensor	6 - 7
Local	6
Remote	7
Frame/Module Assembly	7
System Power Supply	8
Sensor Module	9 - 10
Gas Display	9
Local	9
Remote	9
LCD Display Module	9
LCD Display Setup	10
Closing The Frame/Module Assembly	10 - 11
Programming Gas Locations	12
Model Numbers	13
Spare Part Numbers	14 - 15
Sensors	14
Alert-3 Alarm Accessories	14
Demand Check Valves	15
Dimensions	16

Contents

Troubleshooting	17 - 19
Appendix A	20
Wiring Diagram: LCD Motherboard	
Appendix B	21
Wiring Diagram: Auto-Switch Power Supply	
Appendix C	22
Wiring Diagram: LCD Display Module - Alarm Buzzer	
Appendix D	23
Wiring Diagram: LCD Display Module - Local Sensor	
Appendix E	24
Wiring Diagram: LCD Display Module - Remote Sensor	
Appendix F	25
Wiring Diagram: LCD Display Module - Master Module	
Appendix G	26
Technical Specifications	

User Responsibility

The information contained in this Installation, Operation and Maintenance Manual pertains only to the Alert-3 microprocessor based digital LCD Alarm. This product will perform as described in this manual when assembled, operated, maintained and serviced in accordance with the installation instructions provided.

The alarm must be checked periodically. Parts that are broken, missing, worn, distorted or contaminated must be replaced immediately. Should such repair or replacement become necessary, please contact Amico Corporation or their distributors.

All alarms should not be repaired or altered without prior written or verbal approval from Amico Corporation or its distributors. Failure to comply will void all warranty on the alarm.

Statements in this manual preceded by the words WARNING, CAUTION, DANGER and NOTE are of special significance. Please read these sections carefully.



WARNING: denotes steps which can prevent injury.



CAUTION: denotes steps which can prevent damage to equipment.



DANGER: denotes steps which can prevent electrical shock to equipment or to prevent serious injury and/or death.

Introduction

The Amico Medical Gas LCD Alarm System (Alert-3) incorporates the latest microprocessor based technology for alarm and surveillance systems. The alarm has been designed to provide user flexibility and reliability. This manual shall enable the customer to install, use and maintain the alarm appropriately.

There is one "MUTE" (🔇) or "PUSH TO TEST" button located on the front face of the LCD panel. The button has two functions: to silence an alarm that has occurred and to view the audible alarm sound level and high and low set points. When an audible alarm is triggered, press the button to silence the alarm. To view the audible alarm sound level and high and low set points, press and hold the button for 20 seconds to display the information on the LCD Alarm screen.

All Gases or Vacuums are displayed on the LCD screen for clear visibility to facilitate the monitoring function by hospital personnel. Under normal operation, the gas indicator will be in the "GREEN - OK" position. If an alarm condition occurs, a "RED-Alarm" indicator will be displayed and an audible alarm shall be continuous until silenced by pushing the "MUTE" button.

The LCD Alarm can be connected to a "Building Management System" for a generic alarm indicator.

Features

- Microprocessor based digital LCD and individual microprocessor on each sensor module
- Gas-specific sensors can be mounted locally or remotely, up to 100 feet [30.5 m], utilizing 22 gauge shielded twisted pair (2 shielded wires)
- DISS gas-specific sensor housed in a tamper-proof enclosure. The Sensor Module is housed in an anodized aluminum and nickel-plated brass enclosure to act as an interference barrier
- The Sensor Module is the smallest computer-calibrated temperature-compensated sensor in the industry
- PSI, kPa, inHg or BAR display (programmable)
- Self diagnostic circuitry with error display for problem identification
- Highly accurate Solid State Pressure piezoresistive transducer
- Dry contacts for remote monitoring from LCD for a generic alarm condition
- Modules are factory mounted on a hinged frame assembly for ease of installation and maintenance
- Field programmable push buttons for adjustment of "HI" and "LOW" set-points on display module
- LCD Alarm available in 1 to 8 gases

Description of the Alarm

SHIPMENT DETAILS

When you receive an Alert-3 LCD series alarm from Amico Corporation, the package will consist of three main sections: the Alarm Back Box, Sensors and the Frame/Module Assembly.

THE ALARM BACK BOX

The Alarm Back Box contains the auto-switchable System Power Supply with an ON/OFF switch, a built-in fuse and terminal blocks (115 to 220 VAC - 50 to 60 Hz). The back box also incorporates the pipe stubs for applications that require locally (in box) mounted sensors.

THE FRAME/MODULE ASSEMBLY

The Frame/Module Assembly consists of the frame and the LCD module. The hinged frame is designed to swing down from the back box to facilitate installation and servicing of the alarm. This design will reduce installation time and eliminate the risk of improper installation since all the modules are connected and tested at the factory.

Description of Modules

The Alert-3 LCD Alarm is a high technology microprocessor based module:

COMMON TO ALL ALARMS

SYSTEM POWER SUPPLY

The System Power Supply has been pre-installed into the back box assembly. The System Power Supply converts the AC voltage supply to the alarm into two voltages: 5 VDC (regulated) required by the microprocessor hardware and 15 VDC (unregulated) required by the buzzer and the LCD. This unit also contains the main ON/OFF power switch, the transformer, the heat sink, the main fuse and fuse cover, the rectifying circuitry, the terminal blocks and the low voltage DC power cable for connecting this unit to the module. The System Power Supply can be easily removed and reinstalled by unscrewing it from the back box.

LCD MODULE

The LCD Module contains the LCD screen, microprocessor, buzzer and the "MUTE" buttons. The function of the "MUTE" button is to silence an alarm that has occurred. By holding the "MUTE" button for 15 seconds, the module will display the high and low pressure set points. This module also contains a fail-safe relay that de-energizes when the buzzer is activated. This relay can be used with the Amico Remote Buzzer for applications requiring a remote audible alarm or a Building Management System.

SENSOR MODULE

The Sensor Module contains the transducer which converts the source of the pressure/vacuum into a digital signal that is displayed on the LCD module. The sensor module shall be housed in an anodized aluminum and nickel-plated brass enclosure to act as an interference barrier and it is temperature compensated. Each sensor is clearly labeled and color coded for the gas or vacuum being monitored. The sensor module contains a gas-specific DISS fitting to ensure correct connection of the proper sensor to the respective gas. Each sensor has been factory calibrated by computer for the specific gas shown on the sensor housing.

Installation Guide

STEP 1: THE ALARM BOX

Install the back-box to the studs of the wall at the desired height. Ensure that the box is securely in place. The mounting brackets are adjustable to suit the thickness of the wall. **MAKE SURE** the box is parallel, squared and flush with the finished wall surface to ensure that the frame assembly will fit properly.

STEP 2: FOR LOCAL SENSORS ONLY

If the sensors are to be mounted locally (inside the back box), the pipe stubs must be connected to the pipeline. Using silver-brazing techniques, connect each pipe stub to its appropriate gas or vacuum while ensuring that the bottom of the pipe stub is wrapped with a damp cloth. **BE CAREFUL** not to damage the DISS check-valve by overheating the lower portion of the copper pipe. When the brazing of pipe stubs has been completed, the system can be pressure tested.

STEP 3: STANDING PRESSURE TEST

Perform a standing pressure test on the piping system as per NFPA-99 "Health Care Facilities." Inspect all joints for leaks and make certain each gas is piped to a correspondingly labeled gas service.

STEP 4: SENSOR

LOCAL (inside the back box)

- i. Locate the gas-specific sensor module to be installed.
- ii. In the back box, there are color coded gas labels located under the DISS Demand Check Valves. Each label identifies where each sensor module is to be placed.
- iii. The sensor module contains a gas-specific DISS fitting. Push the sensor module hex-nut and nipple adapter up into the demand check-valve. With a wrench, tighten the nut so that it makes a good seal.

Note: Pressure on sensors are not to exceed 250 psi for pressure sensors and 30 inHg for vacuum sensors.

Alert-3 sensor operating pressure range:

Mid Pressure	(0 to 99 psi)	-	Oxygen, Medical Air, Nitrous Oxide, Carbon Dioxide
High Pressure	(0 to 249 psi)	-	Nitrogen, Instrument Air
Vacuum	(0 to 30 inHg)	-	Vacuum, WAGD, AGSS



Installation Guide

B: REMOTE (outside the back box)

- i. Connect a tee (supplied by others) to the pipeline with a 1/4" NPT female connection that will accept the DISS Demand Check Valve.
- ii. Locate the gas-specific sensor module to be installed.
- iii. Thread the DISS Demand Check Valve into the correct gas pipeline.
- iv. The sensor module contains a gas-specific DISS fitting. Push the sensor module hex-nut and nipple adapter into the demand check-valve. With a wrench, tighten the nut so that it makes a good seal.

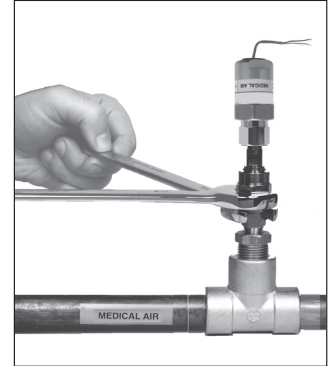

STEP 5: FRAME/MODULE ASSEMBLY

- i. Remove the frame/module assembly from its protective box.
- ii. Remove the corner screws from the front frame section (4 screws).
- iii. Attach the LCD module to the back box assembly by using flat head screws (provided with frame in a plastic bag) to the hinge located on the back box.
- iv. Attach the frame wire with 2 dome head screws (provided with frame in a plastic bag). This will allow the frame assembly and back box to be fastened securely together.



CAUTION: The microprocessor circuitry on the ALERT-3 alarm contains sophisticated integrated semiconductors. If it becomes necessary to remove LCD circuit board, PLEASE hold the boards by the edges. **DO NOT TOUCH** any of the components on the board. Static discharge can cause the modules to malfunction or become damaged.

Installation Guide

STEP 6: SYSTEM POWER SUPPLY



TURN OFF POWER SWITCH before changing any modules and/or disconnecting any cables. Failure to do so can cause the fuse to blow, damaging the circuitry.

- i. Ensure that the ON/OFF switch is in the OFF position.
- ii. Through the top left side of the back box, bring in the AC power wires. Knockouts are provided for making conduit connections to the box. All wiring is to be installed according to local and national codes.
- iii. Connect the AC power to the terminal blocks as shown in the wiring diagram (see Appendix B).

STEP 7: SENSOR MODULE

A: Gas Display (on screen location)

The location of gases displayed on screen is dependant upon which sensor channel each individual gas is connected to. The display below indicates which sensor channel corresponds to each location the gas will be displayed on the LCD screen.

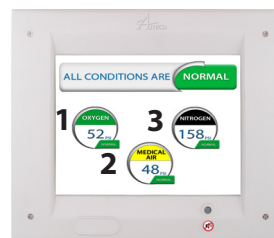

Installation Guide

STEP 7: SENSOR MODULE

B: LOCAL (inside the back box)

- i. The sensor module is provided with a 6"-8" [0.1 m - 0.2 m] twisted pair of wires. One wire is red (positive) and the other wire is black (negative). Connect the wires to the display module as shown in Appendix D. Take the red wire from the sensor and attach it to terminal "Sensor +" on the display module. Take the black wire from the sensor and attach it to terminal "Sensor -". The terminal block on the display module is clearly marked for proper connection of the sensor wires.
- ii. Repeat the above procedures with the remaining sensor modules.

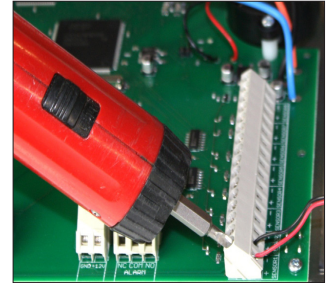

C: REMOTE (outside the back box)

- i. The sensor module is provided with a 6" - 8" [0.1m - 0.2m] twisted pair of wires. Connect the wires to a junction box (not supplied) located near the sensor as per the wiring diagram.
- ii. Connect a shielded twisted pair cable from the junction box to the back box assembly. Knockouts are provided throughout the alarm back box. Up to 100 feet [30.5 m] of 22 Gauge, shielded twisted pair cable should be used.
- iii. Connect the red wire from the cable to the terminal on the display module marked "Sensor +". Connect the black wire to terminal "Sensor -" as shown in the wiring diagram (see Appendix E).
- iv. Repeat the above procedures with the remaining sensor modules using the wiring diagram.

NOTE: When remote sensors are used, a shielded or twisted pair cable is required (BELDEN #8451 or equivalent, supplied by others).

STEP 8: LCD DISPLAY MODULE

If the dry contacts for a generic alarm is to be used for remote monitoring, connect the wires to the appropriate terminals: COM (Common), NO (Normally Open) or NC (Normally Closed), using the diagram in **Appendix A**.

See **Appendix G** for contact rating.

Once the sensors are connected and the power has been turned on, use the following steps to setup the LCD Alarm.

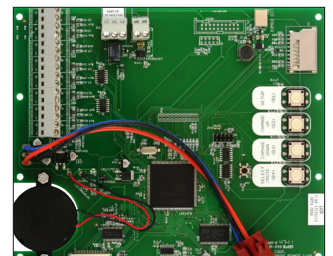

Installation Guide

STEP 9: LCD DISPLAY SETUP

- i. Press the SETUP button (B1) and press the SELECT button (B4)
- ii. Volume control: 90, 80, 70, 60 – press CHANGE UP/DOWN to change noise level
- iii. Press SELECT for LCD brightness and press CHANGE UP/DOWN to change LCD brightness
- iv. Press the SELECT button (B4)

* The following should be displayed.

SENSOR: 1

SENSOR TYPE: show the gas (example: NITROUS OXIDE)

UNITS: PSI (to change to kPA, Bar, inHg, mmHg: press button CHANGE DOWN/UP then press SELECT)

LOW ALARM: 40 (to change: press button CHANGE DOWN/UP then press SELECT)

HIGH ALARM: 60 (to change: press button CHANGE DOWN/UP then press SELECT)

CURRENT PRESSURE: displays exact pressure for the line

CURRENT OFF SET: to re-calibrate pressure reading press button CHANGE DOWN/UP then press SELECT

- v. Repeat steps until all sensors are scanned and data is saved. Next it will show SETUP COMPLETE.

*All gases should now be displayed. If any errors occur, repeat the steps above.

NOTE: Hold the "MUTE" button for twenty (20) seconds to display current low and high set points.

NOTE: Press the Setup button (B1) in order to make corrections/go back.

STEP 10: CLOSING THE FRAME/MODULE ASSEMBLY

- i. Close the frame panel by tightening the screws found on the frame panel to the back box. Ensure that the screws are securely fastened to keep the LCD Alarm closed.
- ii. Carefully place the front frame over the frame panel. Screw in the screws that were removed in **Step 5, part ii**. The alarm shall now be ready for use.

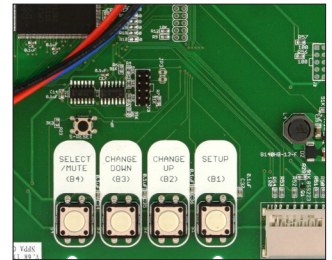

Programming Gas Locations

1. Use the **Notepad** program to enter information for gas location. Each line can hold up to a **maximum of 16 characters**.
2. Two lines may be used per individual gas.
3. The order of the text must go in order of gas; meaning the first two lines of text shall represent the 1st gas location, the next two lines of text shall represent the 2nd gas location, and so forth.
 - Please refer to the diagram in the Installation Guide under section 7a to determine gas location on the LCD Alarm screen.
4. Once all the text has been inputted, save the file on to the SD Card with the file name: **location**.
5. Insert the SD Card into the SD Card Slot on the LCD Alarm board (Refer to Appendix A).
6. While the LCD Alarm is on, press the **reset button**, then press and hold the **setup button** until the information from the file saved on the SD Card (**location.txt**) appears on the LCD Alarm Screen.
 - If the gas location text does not appear on the screen, repeat step #6. If the problem persists, contact Amico Corporation for further assistance.
7. Once the text is visible on the LCD Alarm screen, leave the SD Card in the slot for **approximately 1 minute** in order for the information to be completely uploaded onto the alarm, and then proceed to remove the card.
8. Once the card has been removed, restart the LCD Alarm to ensure that the locations have been saved onto the LCD Alarm.
 - NOTE: Only capital letters and spaces will be displayed on screen. Small caps, symbols and special characters cannot be displayed.
 - Programming of the gas location is only available for V864 and up. If gas location is required, a new front frame assembly is required; part number A3P-FRMAS-LCD.

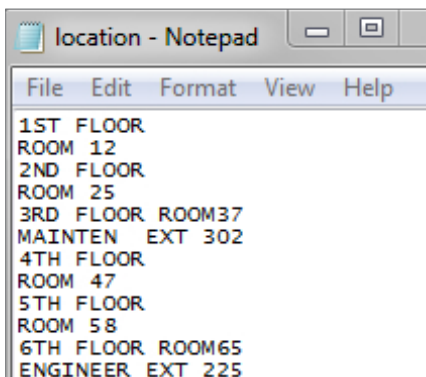

Notepad File

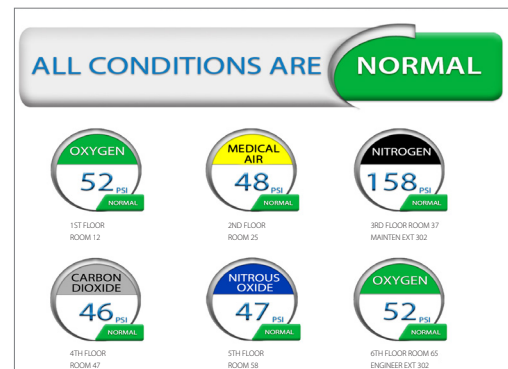

Updated Display on LCD Alarm

Model Numbers

LCD ALARM

A3AR-L-XXXXXXXX

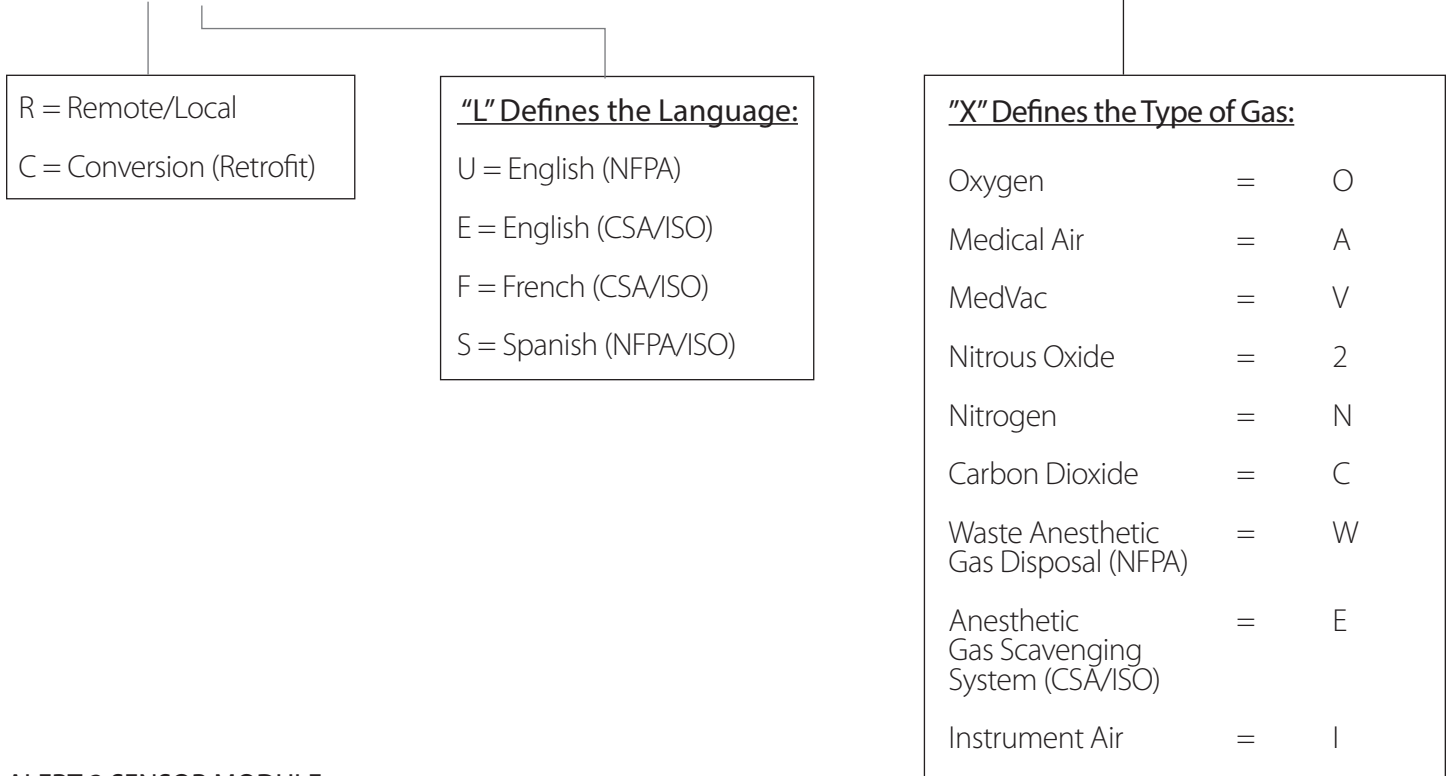

ALERT-3 SENSOR MODULE

A3P-SENS-L-GAS

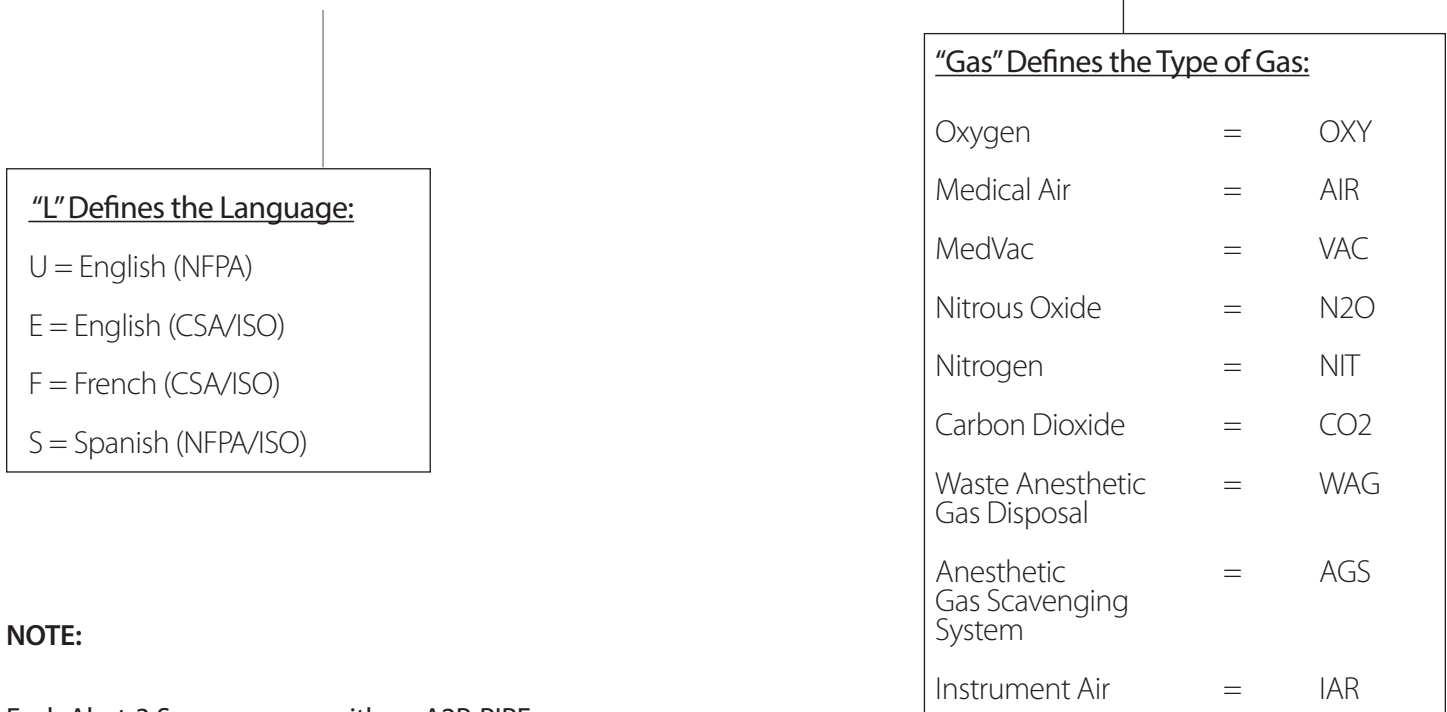

NOTE:

Each Alert-3 Sensor comes with an A2P-PIPE

Spare Part Numbers

SENSORS

Model Number	Description
A3P-SENS-E-AIR	Sensor Module ISO-AIR Eng. Alert-3
A3P-SENS-E-CO2	Sensor Module ISO-CO2 Eng. Alert-3
A3P-SENS-E-AGS	Sensor Module ISO-AGS Eng. Alert-3
A3P-SENS-E-N2O	Sensor Module ISO-N2O Eng. Alert-3
A3P-SENS-E-NIT	Sensor Module ISO-NIT Eng. Alert-3
A3P-SENS-E-OXY	Sensor Module ISO-OXY Eng. Alert-3
A3P-SENS-E-VAC	Sensor Module ISO-VAC Eng. Alert-3
A3P-SENS-E-IAR	Sensor Module ISO-IAR Eng. Alert-3
A3P-SENS-U-AIR	Sensor Module USA-AIR Eng. Alert-3
A3P-SENS-U-OXY	Sensor Module USA-OXY Eng. Alert-3
A3P-SENS-U-VAC	Sensor Module USA-VAC Eng. Alert-3
A3P-SENS-U-WAG	Sensor Module USA-WAG Eng. Alert-3
A3P-SENS-U-IAR	Sensor Module USA-IAR Eng. Alert-3

ACCESSORIES/MISC.

Model Number	Description
A3-MAN-ALM-ENG	Alert-3 Alarm Manual English
A2P-POWER-V2	Power Supply Module Alert-2
A2P-BOXASS-3LCD	Alarm Back Box Assembly 3-Station Alert-2
A3P-FRMASS-LCD	LCD Alarm Frame Assembly for LCD Alert-3
A2P-PIPE	Pressure Module Pipe Assembly (Alert-2)
A3P-DEMO-CASE	Alert-3 Demo Alarm
A2X-BOX-3-FILL	Alert-2 Alarm Box Filler Frame 3-Station
A3X-P-SW-PVCAP	LCD PVA Switch Cap-Gray
A3X-LCD-LABEL	LCD Alarm Front Label
A3X-LCD-LABEL-MUTE	Alert-3 Mute Label

Spare Part Numbers

DEMAND CHECK VALVES

Model Number	Description
S-DIS-DEMC-AIR	DISS Demand Check Valve 1/4" MNPT - AIR
S-DIS-DEMC-CO2	DISS Demand Check Valve 1/4" MNPT - CO2
S-DIS-DEMC-NIT	DISS Demand Check Valve 1/4" MNPT - NIT
S-DIS-DEMC-N2O	DISS Demand Check Valve 1/4" MNPT - N2O
S-DIS-DEMC-EVA	DISS Demand Check Valve 1/4" MNPT - EVA
S-DIS-DEMC-OXY	DISS Demand Check Valve 1/4" MNPT - OXY
S-DIS-DEMC-VAC	DISS Demand Check Valve 1/4" MNPT - VAC
S-DIS-KIT-OXY	DISS Demand Check, Nut and Nipple - OXY
S-DIS-KIT-AIR	DISS Demand Check, Nut and Nipple- AIR
S-DIS-KIT-VAC	DISS Demand Check, Nut and Nipple- VAC
S-DIS-KIT-N2O	DISS Demand Check, Nut and Nipple - N2O
S-DIS-KIT-NIT	DISS Demand Check, Nut and Nipple - NIT
S-DIS-KIT-WAG	DISS Demand Check, Nut and Nipple- WAG
S-DIS-KIT-AGS	DISS Demand Check, Nut and Nipple- AGS
S-DIS-KIT-IAR	DISS Demand Check, Nut and Nipple - IAR
S-DIS-KIT-CO2	DISS Demand Check, Nut and Nipple - CO2
A3P-LCD-FILLER-4	Alert-3 Filler Frame 4 - Station
A2X-BOX-4-FILL	Alert-2 Alarm Box Filler Frame 4 - Station
A3P-LCD-FILLER-5	Alert-3 Filler Frame 5 - Station
A2X-BOX-5-FILL	Alert-2 Alarm Box Filler Frame 5 - Station
A3P-LCD-FILLER-7	Alert-3 Box Filler Frame 7 - Station
A2X-BOX-7-FILL	Alert-2 Box Filler Frame 7 - Station

Dimensions

LCD ALARM

Front View

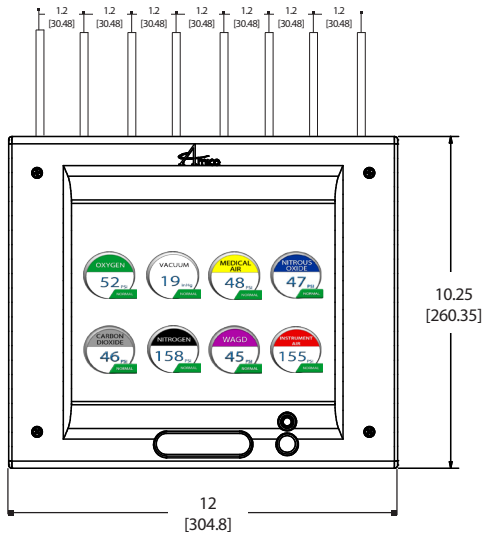

Side View

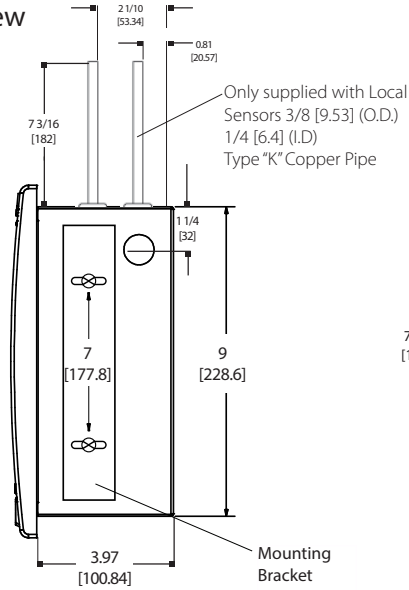

Inch [mm]

NOTE: DISS demand check valves by 1/4" NPT, supplied with each sensor

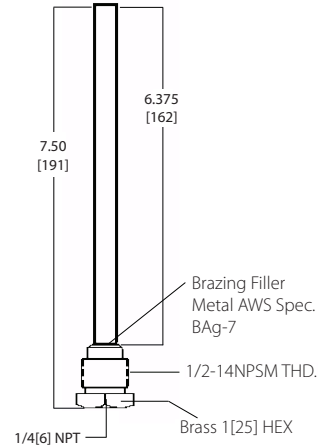

Top View

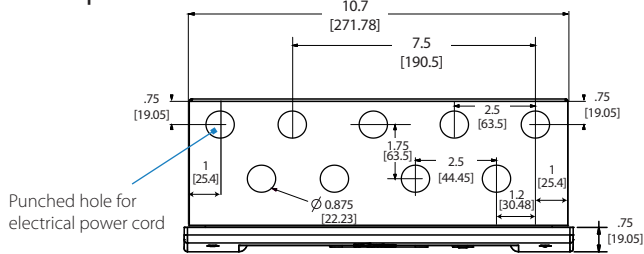

Bottom View

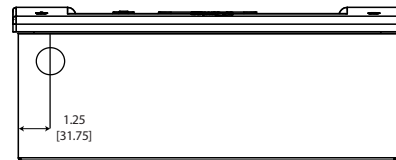

ALERT-3 SENSOR

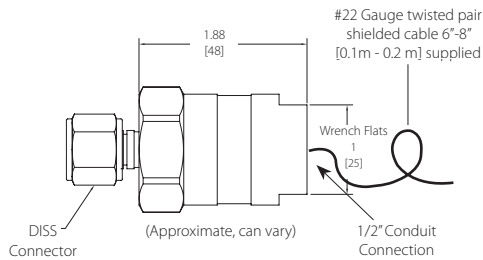

1/2"-14 NPSM [13]

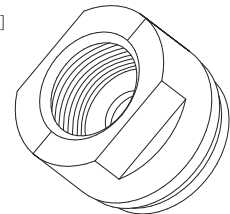

Troubleshooting

Symptom	Cause	Corrective Action
An error or "LOW ALARM" LCD screen	The Microprocessor detected a fault and has shut down	Turn power switch to OFF position. Wait for at least 5 seconds before turning ON the power. The program will reset itself.
	Faulty wire connection between the sensor and LCD module	Check wiring diagram in Appendix D and Appendix E
No power on the alarm	AC power not available	<ol style="list-style-type: none"> Ensure that the ON/OFF switch on the power supply module is turned ON (see Appendix B). AC wiring not connected. Check the building electrical breaker to ensure that the power is ON. Check the voltage at the terminal block above the transformer. Ensure that 115 VAC to 220 VAC is being supplied.
	Fuse is blown	Check the fuse. The fuse is located on the upper-right corner of the system power supply. Replace the fuse if it is defective (see Appendix B and Appendix G).
	DC power plug not connected to the LCD module	<ol style="list-style-type: none"> Ensure that the DC power plug is firmly in its socket on the LCD module. Replace the System Power Supply unit if all the above steps fail to resolve the problem.
Power light is ON, however there is no display on LCD screen	Power failure on screen	<ol style="list-style-type: none"> Remove all transducers and reset power Replace the LCD module.
No audible alarm	DC power cable is disconnected, loose or check ribbon cable	<ol style="list-style-type: none"> Ensure that the DC power cable from the system power supply is firmly connected to the LCD module. Replace LCD board.
Audible signal will not silence	Faulty display module	Disconnect the ribbon cable from the back of the faulty display module and replace the LCD module.
	Connection of the DC power cable from system power supply to LCD module is loose	Disconnect the DC power cable from the LCD module and then reconnect. If audible alarm still persists, replace the System Power Supply unit.
	Faulty push button	Replace the LCD module.

Troubleshooting

Symptom	Cause	Corrective Action
Gas reading incorrect	Loose connection of DISS fittings	Ensure that the sensor module is properly connected to the DISS demand check-valve
	Sensor module is not properly wired to the display module	Ensure that the sensor module is properly wired to the LCD module by using wiring diagram in Appendix D or Appendix E
	Defective sensor or requires calibration	Replace the sensor module
	Defective LCD display module	Replace the LCD display module
Display shows "NO SENSORS"	No sensor(s) are connected to the LCD board	Make sure sensor module(s) are connected to LCD board (see Appendix D and Appendix E)
	Program not set up	Press setup and select button to program all connected sensors (see LCD Display Set-Up in Section 9)
	Faulty sensors	Replace sensors

FACTORY DEFAULT SETTING GAS

Mid Pressure Hi = 60 psi
 Low = 40 psi

Vacuum Hi = 32 inHg
 Low = 12 inHg

High Pressure Hi = 195 psi
 Low = 140 psi

Appendix A

WIRING DIAGRAM: LCD MOTHERBOARD

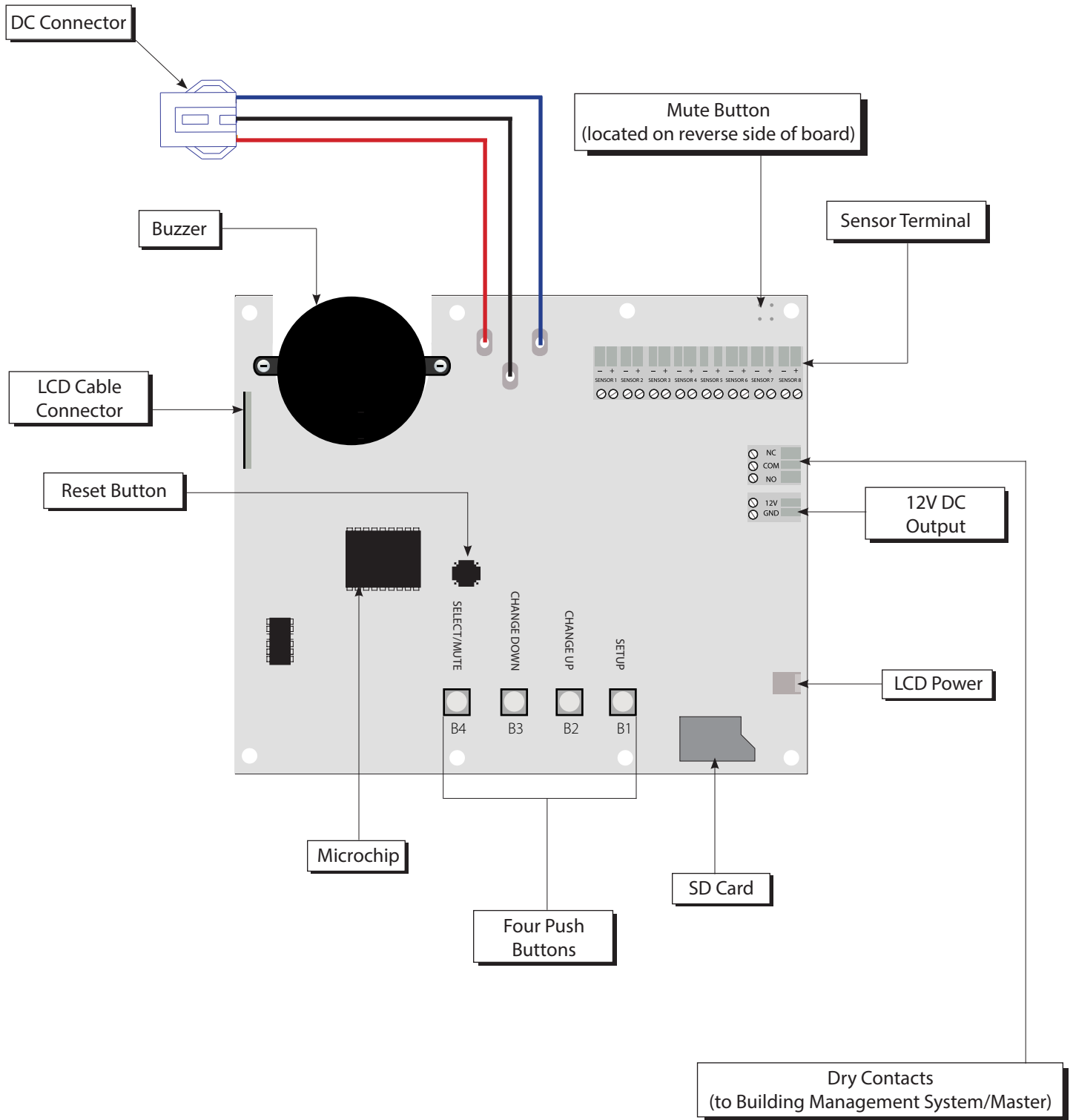

Appendix B

WIRING DIAGRAM: AUTO-SWITCH POWER SUPPLY

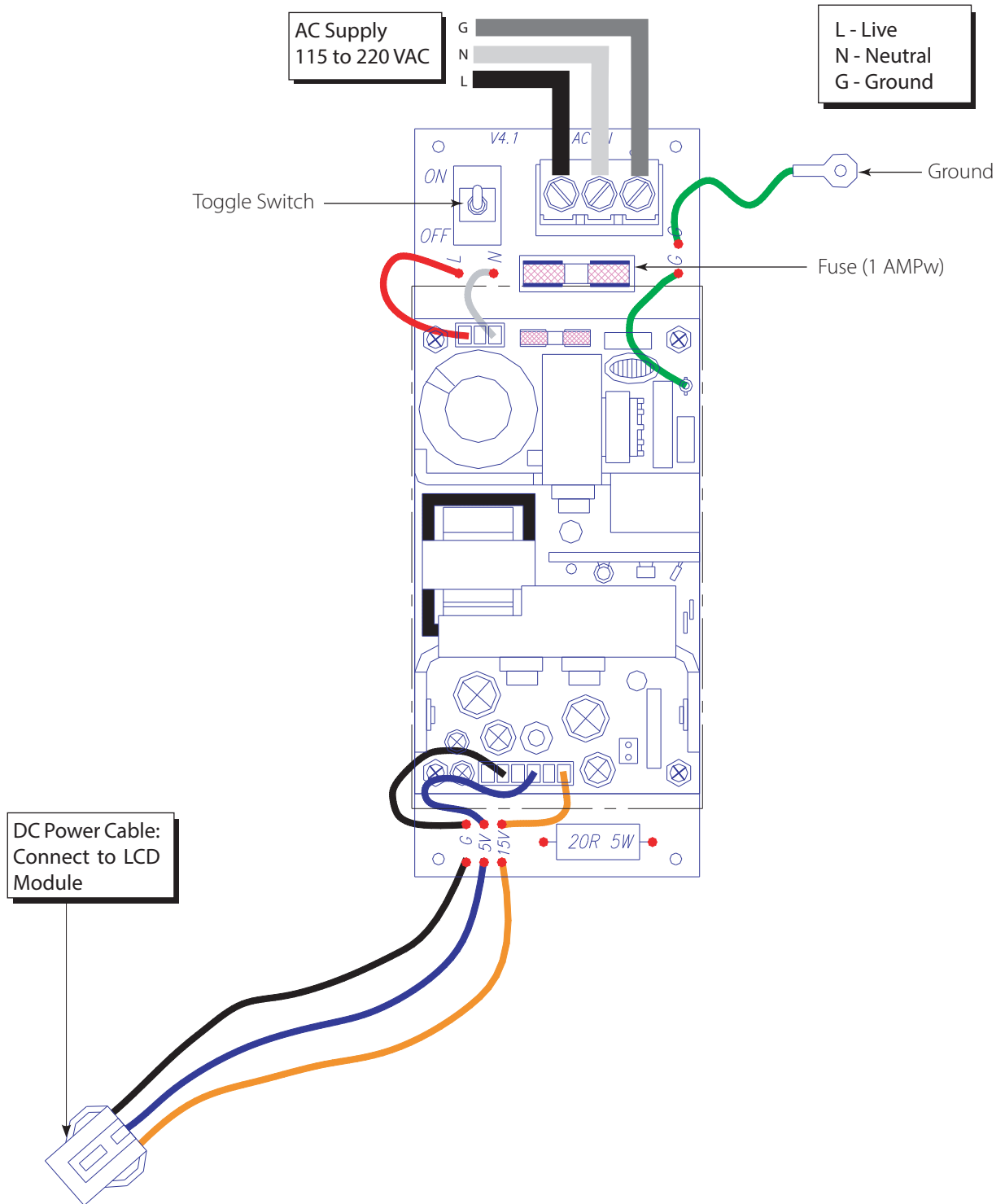

Appendix C

WIRING DIAGRAM: LCD DISPLAY MODULE - ALARM BUZZER

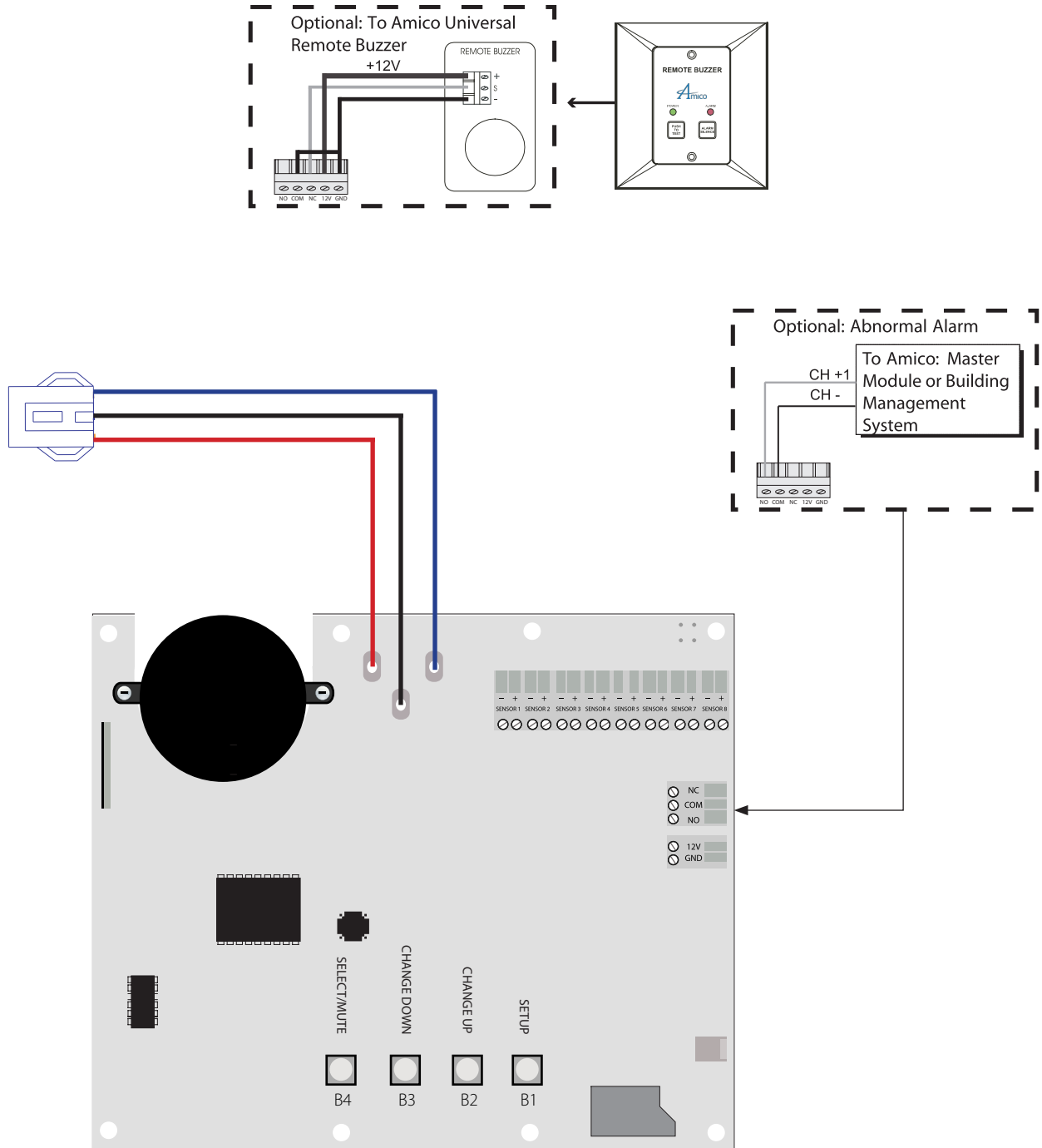

Appendix D

WIRING DIAGRAM: LCD DISPLAY MODULE - LOCAL SENSOR

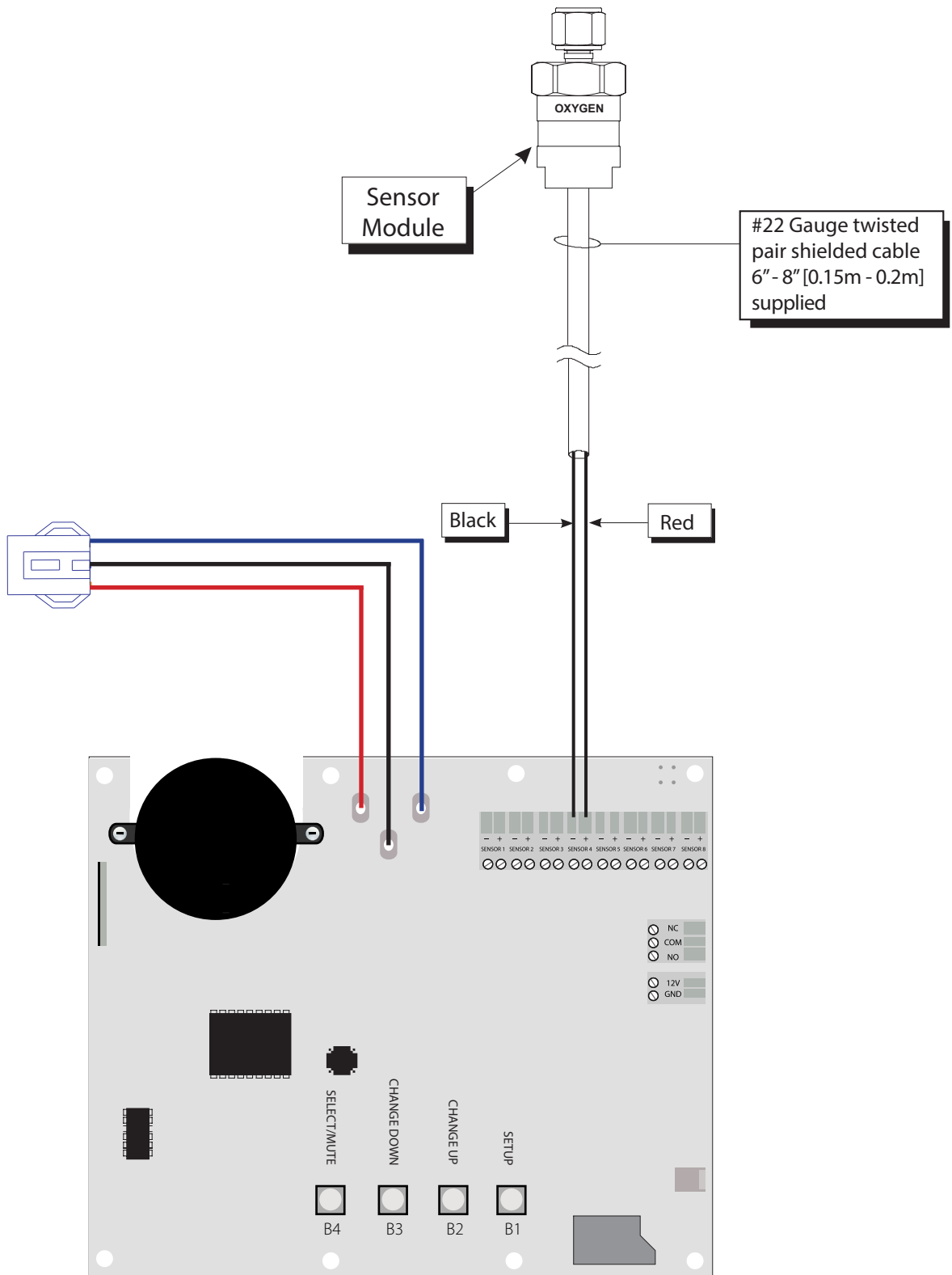

Appendix E

WIRING DIAGRAM: LCD DISPLAY MODULE - REMOTE SENSOR

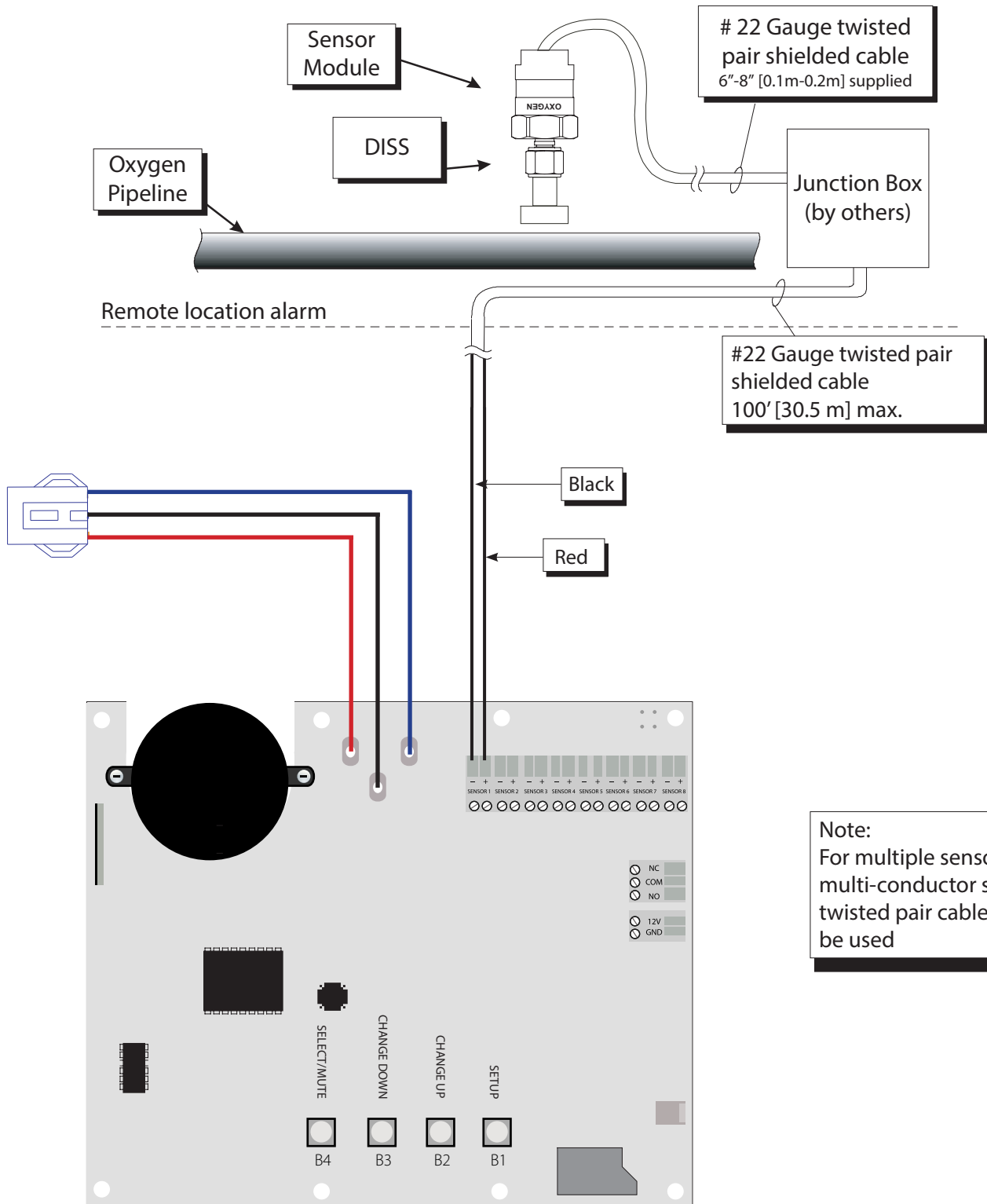

Appendix F

WIRING DIAGRAM: LCD DISPLAY MODULE - MASTER MODULE

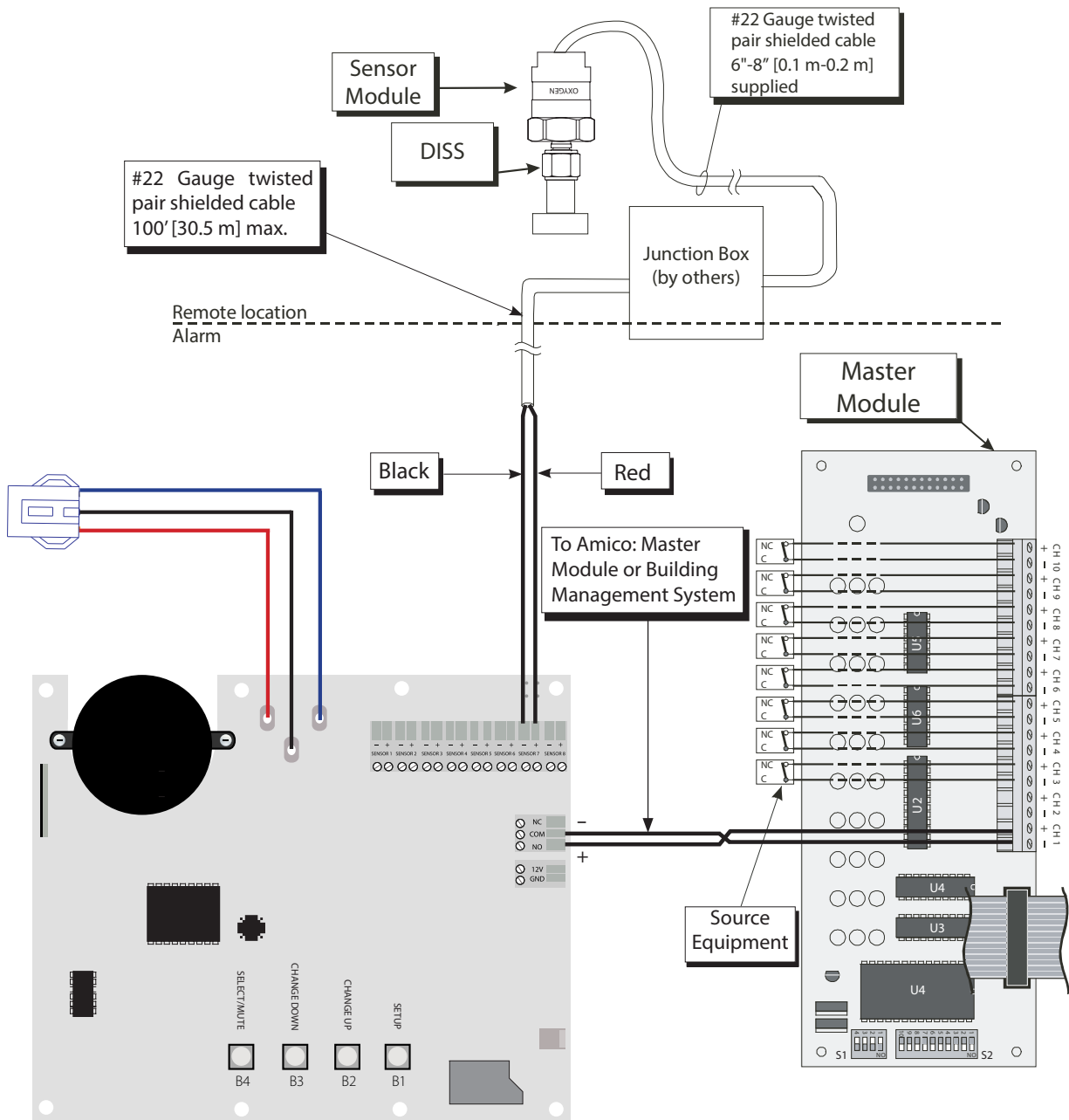

NOTE:

Jumper any unused points on the Master module

Turn OFF dip-switches for any unused points (Location SW-2)

Appendix G

TECHNICAL SPECIFICATIONS

Supply Voltage: 115 - 220 VAC, 50 - 60 Hz

Current Draw: 1 Amp. Max.

Fuse (1/4 * 1-1/4): Fast Blow 1 Amp.

Cable requirement:

LCD Alarm to Remote Sensor:

Important:

Cable: Belden # 8451 or equivalent. #22 gauge shielded, twisted pair. (For multiple sensors a multi-conductor twisted pair, shielded cable should be used).

Distance: Maximum 100 ft [30.5 m]

Signal: 30 VDC - 1.0 Amps.

60 VDC - 0.3 Amps.

125 VAC - 0.5 Amps.

LCD Alarm to Master:

Distance: Maximum 10,000 ft [3,000 m]

Cable: Minimum #22 gauge wire

Signal: 5 VDC - < 5 μ A

LCD Generic Alarm:

Output: Dry Contacts NC, open on Alarm

Rating: 30 VDC - 1.0 Amps.

60 VDC - 0.3 Amps.

125 VAC - 0.5 Amps.

www.amico.com

Amico Corporation | www.amico.com

85 Fulton Way, Richmond Hill
Ontario, L4B 2N4, Canada

Toll Free Tel: 1.877.462.6426
Toll Free Fax: 1.866.440.4986
Tel: 905.764.0800
Fax: 905.764.0862
Email: info@amico.com

